

Congratulations on your new VELUX INTEGRA® product!

Thank you for buying this VELUX INTEGRA® product.

The control pad has been produced and tested in accordance with the newest methods and strictest requirements and will help you to get the most out of all your VELUX INTEGRA® products.



Contents

Important information	4
1 Control pad	
Control pad functions	5
2 Operation	
Basic operation	
Operation of windows	6
Operation of sunscreening products	7
Operation of lights	8
Operation of products connected to on/off switch	8
Operation of other types of io-homecontrol® products	8
Product position	8
Turn on/Home/Stop all products	8
Programs	
Using programs	9
VELUX programs	10-14
- Using a program	10-11
- Editing a program	12-13
- Adding a program to the product navigator	14
- Resetting to default settings	14
Own programs	15-22
- Creating a program	15-17
- Editing a program	18-19
- Adding a program to the product navigator	20
- Renaming a program	21
- Silent mode operation	22
- Deleting a program	22
Smart operation	
Finding products	23
Keyboard	23
Renaming products	24
Groups	25-28
- Creating a group	25
- Editing a group	26
- Renaming a group	27
- Deleting a group	28
Rooms	29-32
- Creating a room	29
- Editing a room	30
- Renaming a room	31
- Deleting a room	32

Contents

Favourites	33-34
- Editing order of products in the product navigator	33
- Editing favourites	34

Operation without using the control pad

Manual operation of centre-pivot windows	35
Closing centre-pivot windows in case of power failure or discharged battery	36
Closing windows if the control pad has been mislaid	37

3 Setting up

Start-up of a new VELUX INTEGRA® system

Initial set-up	38
If the initial set-up fails	39

Extension of your VELUX INTEGRA® system

Adding products to the control pad	40
Adding a control	41-93
- Adding a control to your system already operated with a VELUX INTEGRA® control pad KLR 200	41-53
- Adding a VELUX INTEGRA® control pad KLR 200 to your system already operated with another control	54-68
- Allowing controls already in use in their separate systems to operate each other's products	69-93
Deleting products in the control pad	94
Joint operation of io-homecontrol® products	95-97
- Sending the security key to another io-homecontrol® control	96
- Receiving the security key of another io-homecontrol® control	97
- Creating a new security key in VELUX INTEGRA® control pad KLR 200	97

Settings

Time and date	98-99
Language	100
Silent mode operation of products	100

Resetting the control pad

	101
--	-----

Security

Password	102
Changing the security key	103-113

4 Installation

Fitting the control pad to the wall	114
Repositioning the rain sensor in case of retrofitting	115

Declaration of conformity

	116
--	-----

Important information

Read instructions carefully before installation. Please keep instructions for future reference and hand them over to any new user.

Note: These instructions cover products, product features and product offerings that may vary with markets and selected language. Consequently, the display illustrations, the display texts and the available features related to your product may differ from what is shown in these instructions. Contact your VELUX sales company for specific information, see telephone list or www.velux.com.

Safety

- The control pad is intended for operation by persons with the relative experience and knowledge or persons who have been given instruction concerning its use by a person responsible for their safety.
- Children must not be allowed to play with the window and its electrical products, and the control pad should be kept out of their reach.
- If repair or adjustment work is needed, disconnect from mains or battery supply and ensure that it cannot be reconnected unintentionally.
- Before operating, ensure that the window and its electrical products can be operated without risk of damage to property or injury to people or animals.
- For personal safety, never have your hand or body out of the window without first having switched off the mains or battery supply.

Function

- If the rain sensor gets wet, the window operator automatically closes the window; however, the ventilation flap remains open.
- Disabling the rain sensor implies acceptance of the risk of rain water being able to enter the building while the window is open.
- To prevent the window from closing because of very fine/weak rain, fog or dew, the rain sensor is equipped with a heating element to keep the surface dry.
- If the window has been opened manually, the window operator will not be activated via the rain sensor or other automatic functions.
- From fully open, it will take up to one minute from the time of activation before the window is completely closed. Therefore, in case of sudden rain, water may enter the room before the window is closed.
- In case of snow and/or ice, the operation of the window may be blocked.
- It is recommended to place a control pad in the room where the window and its electrical products have been installed.

Product

- The control pad has been designed for use with genuine VELUX products. Connection to other products may cause damage or malfunction.
- The control pad is, within each market region, compatible with products with the io-homecontrol® logo.
- Electrical products must be disposed of in conformity with national regulations for electronic waste and not with household waste.
- Used batteries must not be disposed of together with household waste but have to be disposed of in conformity with the relevant national environmental regulations. Batteries contain substances that can be harmful if not handled and recycled correctly.
- ⚠ Use local authority battery disposal point where available.
- The packaging can be disposed of with usual household waste.
- Sound pressure level: Max 70 dB(A).
- Radio frequency band: 868 MHz within Europe and 2.4 GHz in most countries outside Europe.
- Radio frequency range: 200 m free field. Depending on building construction, the indoor range is approx 20 m. However, constructions with reinforced concrete, metal ceilings and plaster walls with steel members may reduce the range.
- Expected battery lifetime of control pad: Up to 1 year.
- Expected battery lifetime of solar powered window operator: Approx 10 years.

Maintenance and service

- Disconnect from mains or battery supply before carrying out any maintenance or service work to the window and products connected to it and ensure that it cannot be reconnected unintentionally during this time.
- Maintenance and installation must be carried out in consideration to Health and Safety at work requirements.
- If mains cable is damaged, it must be replaced by qualified personnel in accordance with national regulations.
- Clean the control pad with a soft dry or damp cloth.
- Dirt on the rain sensor may cause operating problems. Therefore, it is recommended to clean the rain sensor with a soft, wet cloth once or twice a year or when needed.
- In case of accumulation of dirt, the solar cell should be cleaned with water and ordinary household cleaners.
- Spare parts are available through your VELUX sales company. Please provide information from the data label.
- If you have any technical questions, please contact your VELUX sales company, see telephone list or www.velux.com.



io-homecontrol® provides advanced and secure radio technology that is easy to install. io-homecontrol® labelled products communicate with each other, improving comfort, security and energy savings.

www.io-homecontrol.com

Control pad
Control pad functions

1

Shows product location

Running program
Low battery

Product navigator.
Shows operable product or program

Activates products, for instance closing a window or running up a blind

Sets the product position, for instance running a blind partly down

Pre-set closing
Awning blind control
Roller shutter with upper/lower elements

Opens the ventilation flap of the window. The window is still closed

Light gauge

Access to programs and settings

Stops running products. Shows the position of the product shown in the display

Activates products, for instance opening a window or running down a blind

Indicates the product position from 0-100. A fully opened window is 100 (100 % open), and a fully closed blind is 100 (100 % closed)

Tapping the Home button turns on the display again after sleep mode and shows the first product in the product navigator. Touching and holding it for 3 seconds stops all products

Battery compartment

Diode

Key button

RESET button

USB stick (type micro-USB B)

Release button for battery compartment lid

Operation
Basic operation

2

You can operate all products by tapping icons/buttons or by dragging the slider and tapping the bar in the display.

The product to be operated is shown in the middle of the product navigator display. If more products are registered in the control pad, they are shown as shadows in the display sides. Select the product you want to operate by swiping a finger over the display in the directions of the arrows.



Operation of windows

- ① Close
- ② Stop
- ③ Open
- ④ Open ventilation flap only. The window is still closed.
- ⑤ Drag the slider or tap the bar to open the window to desired position. The position from 0-100 is shown in the bottom right corner.
- ⑥ Tap the clock to close the window automatically after a given period of time.
- ⑦ Choose for how many minutes the window is to be open and tap "OK".
- ⑧ The icon in the bottom left corner shows for how many minutes the window will still be open.

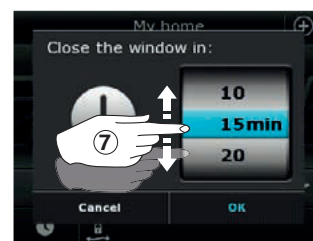
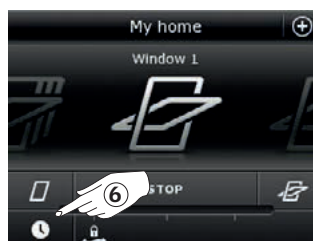
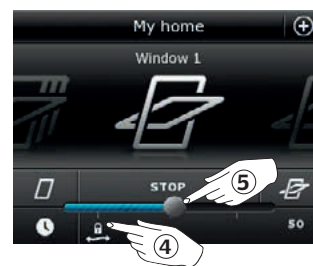

Note: If you try to open a window while it is raining, only the ventilation flap will be opened. This function prevents the rain from coming in. Tap "OK" to accept.

Alternatively, tap "Open anyway" if you want to open the window even if it is raining. The window can now be opened up to a maximum of 50 %. After 15 minutes, the window will close automatically if it is still raining.

If you set the automatic closing to less than 15 minutes, the window will close automatically at the end of this time period.

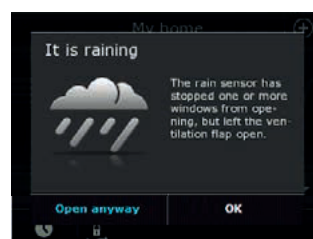

Operation
Basic operation

2

Operation of sunscreening products

Roller shutters/Awnings blinds/Blinds

- ① Run up
- ② Stop
- ③ Run down
- ④ Drag the slider or tap the bar to set the position of the sun-screening product. The position from 0-100 is shown in the bottom right corner.

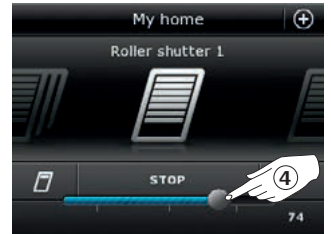

Roller shutters with upper/lower elements

- ⑤ Tap ●●●.
- ⑥ Tap the element you want to operate.
- ⑦ Tap "OK". You can now operate the element as described above.

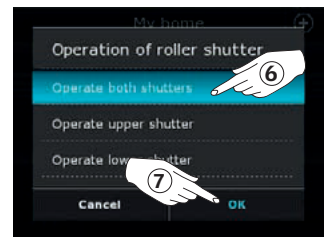
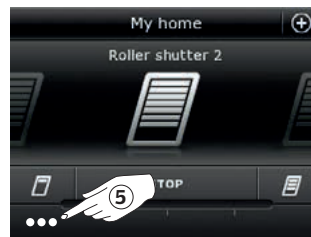

Venetian blinds

- ① Run up
- ② Stop
- ③ Run down
- ④ Drag the slider or tap the bar to set the position of the Venetian blind. The position from 0-100 is shown in the bottom right corner.
- ⑤ Tap ↶↷ to set the tilting of the slats.
- ⑥ Tap ↶ to tilt the slats upwards.
- ⑦ Stop
- ⑧ Tap ↷ to tilt the slats downwards.
- ⑨ Drag the slider or tap the bar to set the tilting of the slats. The tilting from 0-100 is shown in the bottom right corner.
- ⑩ Tap ⬆️⬆️ to return to setting the position of the Venetian blind.

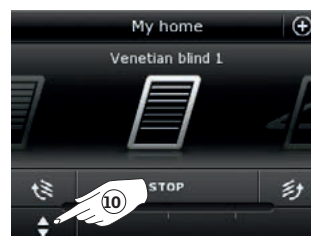
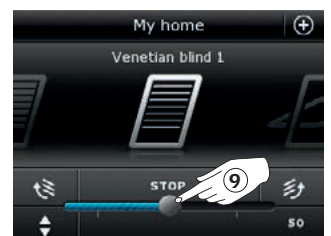
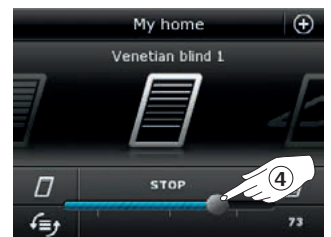

Operation
Basic operation

2

Operation of lights

- ① Turn off
- ② Stop
- ③ Turn on
- ④ Drag the slider or tap the bar to set the intensity of the light.
The intensity from 0-100 is shown in the bottom right corner.

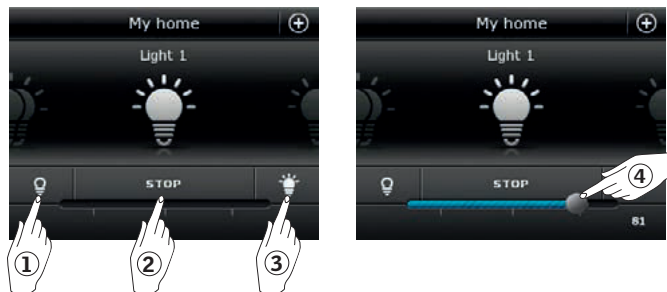

Operation of products connected to on/off switch

- ① Turn off
- ② Turn on



Operation of other types of io-homecontrol® products

- ① Open
- ② Stop
- ③ Close

Note: The example shows a garage door.

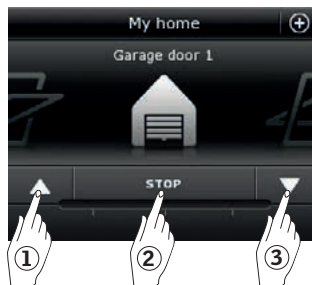

Product position

Tap "STOP" and the position of the product can now be seen in the bottom right hand corner of the product navigator display. For instance, you can see how far a window is open.



Turn on/Home/Stop all products

To prolong the lifetime of the control pad batteries, the display goes into sleep mode shortly after the last touch. You turn on the display again by tapping .

When the display is on, a tap on  takes you home to the first product in the product navigator.

Touching and holding  for at least 3 seconds stops all products.



Operation

Programs - Using programs

2

A program can help you get a smarter home. It can ensure that your house is ventilated regularly, that internal temperatures are kept down during the day when necessary, and that the heat loss is reduced at night.

Tap ⊕ in the top right corner of the display to get access to the programs.



Under "Programs", you will find the VELUX programs available for the products registered in your control pad. The more different products registered, the more VELUX programs available. There are eight VELUX programs.

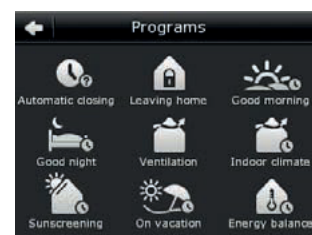
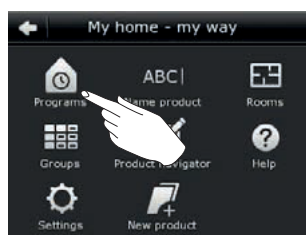

Two programs will run only once when activated. You can edit these programs.



Ventilation



Leaving home

Six programs, when activated, will automatically run repeatedly according to a set schedule until you stop them. You can edit the programs. A clock at the bottom right of the program icons indicates that the program will run repeatedly.



Good morning



Sunscreening



Good night



On vacation



Indoor climate



Energy Balance

In addition, you can make your own programs, see the section *Creating a program*. Here you can combine the program settings as you wish.

When choosing a VELUX program, its contents are shown on the display. Tap ⇐ to go back.

Tap "Start" to activate a program. Tap "Edit" to change the individual actions/settings of the program to make them match your wishes.

Tap ⊗ to go back.

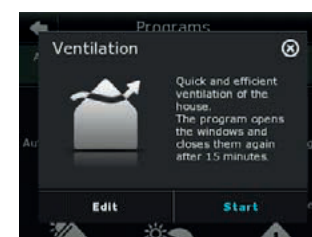
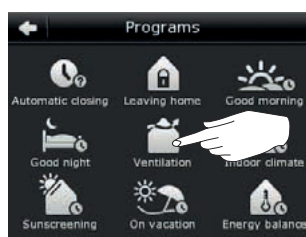

Operation

Programs - VELUX programs

2

Using a program

Two examples of how to use VELUX programs are shown.

Example 1

The program "Ventilation" makes it easy to open and close your windows.

The example shows how to use it.

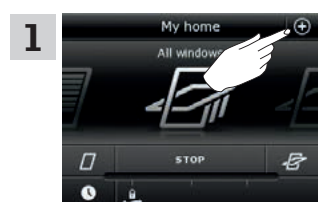

1 Tap ⊕.

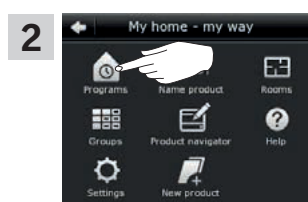

2 Tap "Programs".

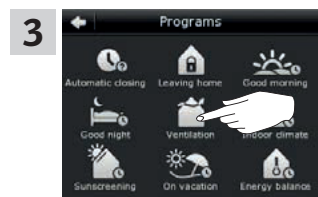

3 Tap "Ventilation".

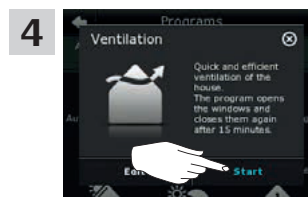

4 Tap "Start".

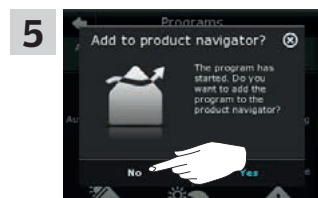

5 The display asks if you want to add the program to the product navigator for easier access. Tap "No".

Note: Tap "Yes" if you want to add the program to the product navigator (see page 14).

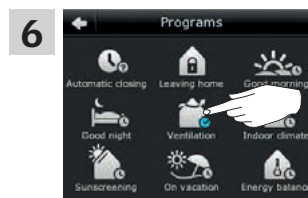

6 The clock turns blue when the program is running. Tap "Ventilation" to stop the program.

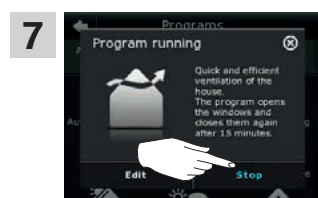

7 Tap "Stop".

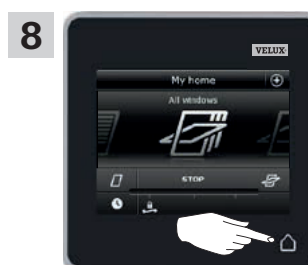

8 Tap ⊕ to finish.

Operation

Programs - VELUX programs

Example 2

The program "Leaving home" ensures that all windows are closed and that all registered locks are operated.

The example shows how to use it.

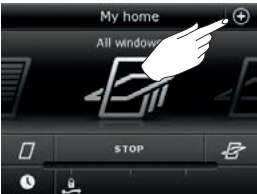
1  Tap ⊕.

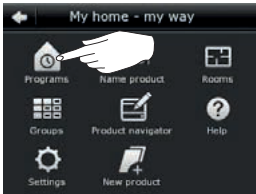
2  Tap "Programs".

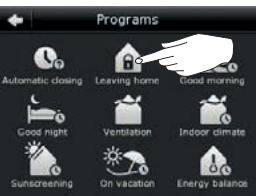
3  Tap "Leaving home".

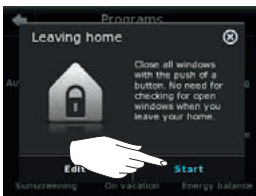
4  Tap "Start".
Note: The display notifies you if a window has been opened manually. This window must be closed manually again to enable you to secure your home.

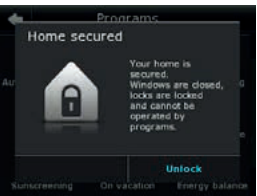
5  Your home is now secured until you tap "Unlock".

NOTE!

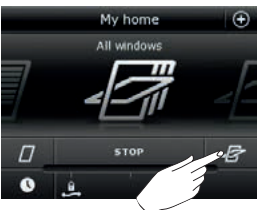
 After starting "Leaving home", you can still operate **products** ordinarily with another control pad or control.

 However, if you try to activate a **program**, the display shows that operation has been blocked.

Operation

Programs - VELUX programs

Editing a program

You can change the settings in a program to make it suit you better.

The example shows how to change the settings in the program "Ventilation" into opening just one window and setting its opening position for ventilation purposes.

- 1**

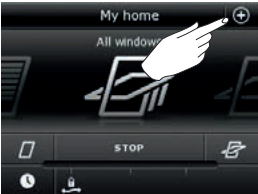

Tap ⊕.
- 2**

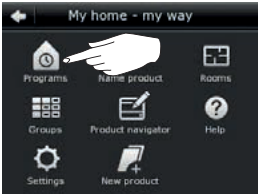

Tap "Programs".
- 3**

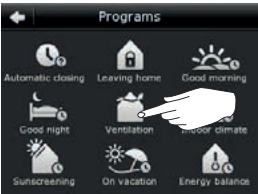

Tap "Ventilation".
- 4**

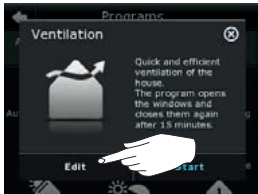

Tap "Edit".
- 5**

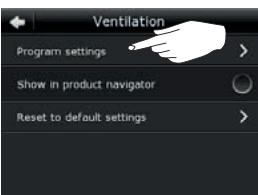

Tap "Program settings".
- 6**

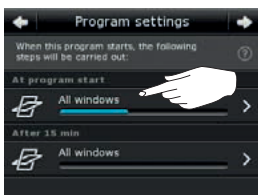

Tap "All windows".
- 7**



Tap "All windows".
- 8**



Remove ticks for the windows not to be opened ①.
Note: The individual products can be identified by tapping the icon. See also the section *Finding products*.
Tap ⇒ ②.
- 9**

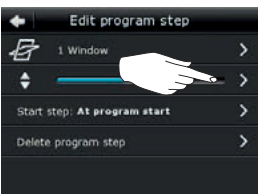

Tap the bar with the blue slider.
- 10**



Drag the slider or tap the bar to open window to desired position. The position from 0-100 is shown in the bottom right corner ①.
Tap ⇒ ②.

Operation

Programs - VELUX programs

2

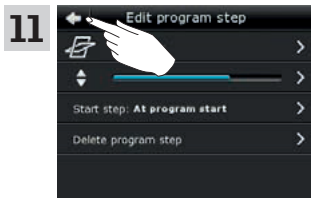

Tap ←.

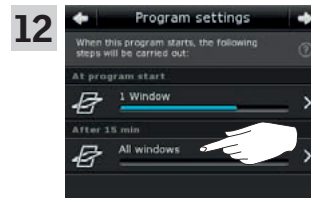

Tap "All windows".

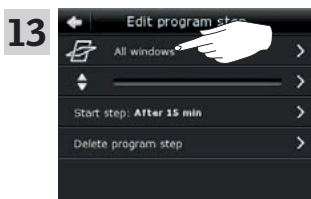

Tap "All windows".



Remove ticks for the windows not to be closed ①.
Note: The individual products can be identified by tapping the icon. See also the section *Finding products*.
Tap ⇒ ②.

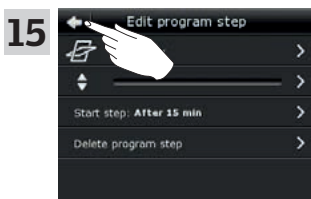

Tap ←.

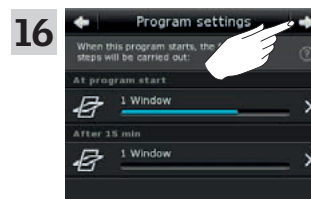

Tap ⇒.



Tap ◻ to finish.

Operation

Programs - VELUX programs

Adding a program to the product navigator

You can place your program in the product navigator to make it easier to activate.

The example shows how to add the program "Ventilation" to the product navigator.

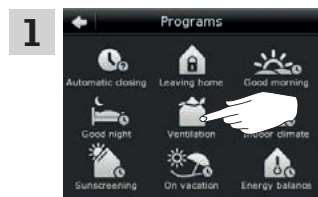

Tap "Ventilation".



Tap "Start".

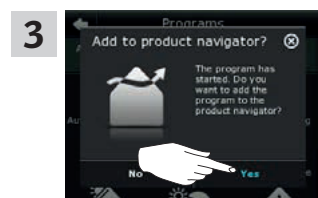

The display asks whether you want to add the program to the product navigator.
Tap "Yes".

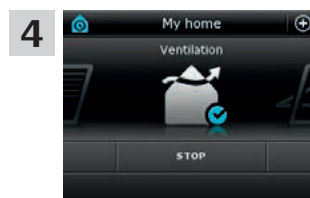

Now the program has been added to the product navigator where you can access it easier.

Resetting to default settings

To cancel your settings, you can reset to default settings.

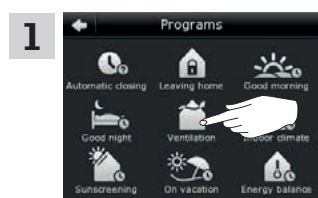

Tap "Ventilation".

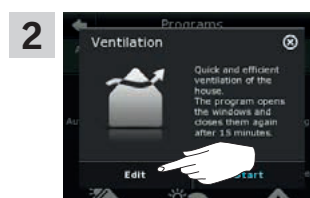

Tap "Edit".

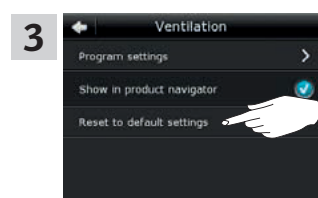

Tap "Reset to default settings".

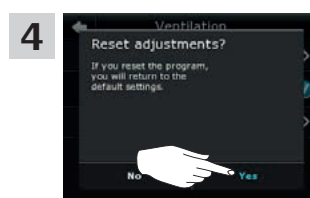

Tap "Yes".

Operation

Programs - Own programs

2

Creating a program

If the VELUX programs do not cover your requirements, you can make your own program. You may for instance need to ventilate a room at a certain time every day.

The example shows how to make a program with the name "Night cooling".

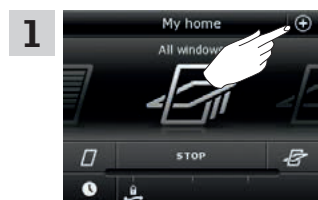

1 Tap ⊕.

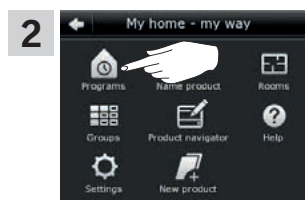

2 Tap "Programs".

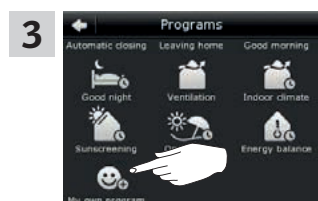

3 Tap "My own program".

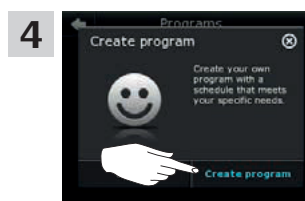

4 Tap "Create program".

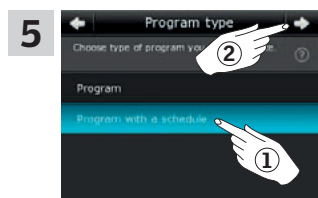

5 Tap "Program with a schedule" if the program is to be repeated on selected days ①. **Note:** Tap "Program" only if the program is to run immediately. Tap ⇒ ②.

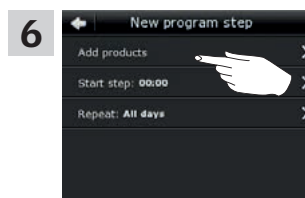

6 Tap "Add products".

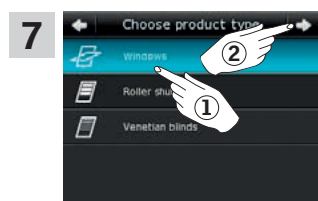

7 Tap "Windows" ①. Tap ⇒ ②.



8 Scroll down the display and tick the windows to be included in the program ①. **Note:** The individual products can be identified by tapping the icon. See also the section *Finding products*. Tap ⇒ ②.

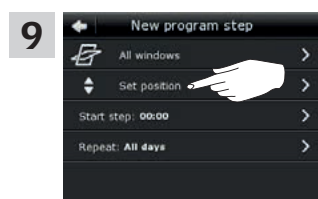

9 Tap "Set position".

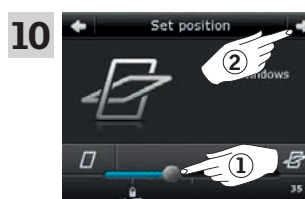

10 Drag the slider or tap the bar to set the opening of the windows. The position from 0-100 is shown in the bottom right corner ①. Tap ⇒ ②.

Operation
Programs - Own programs

2

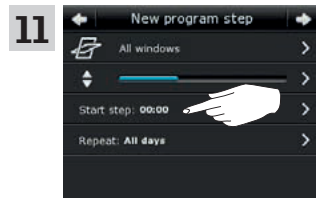

Tap "Start step: 00:00".

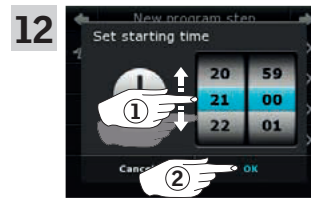

Roll the wheel to set the time to open the windows ①.
Tap "OK" ②.

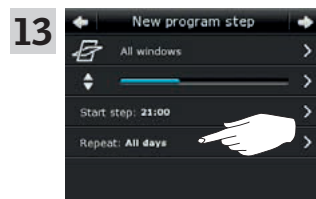

Tap "Repeat: All days".

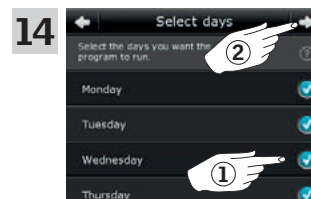

Scroll down the display and remove tick for the days not to be part of the program ①.
Tap ⇨ ②.

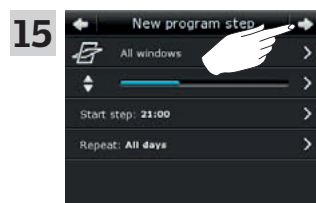

Tap ⇨.

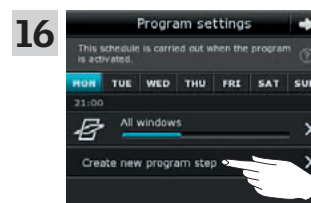

Tap "Create new program step" to set the time to close the windows again.

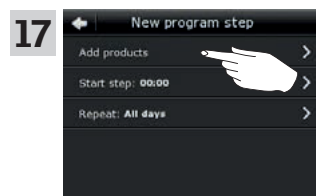

Tap "Add products".

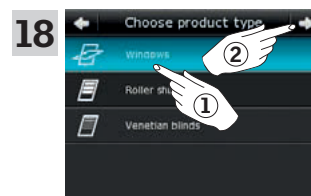

Tap "Windows" ①.
Tap ⇨ ②.

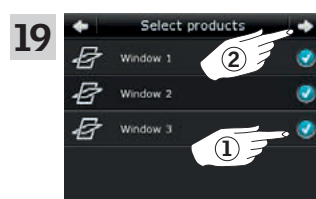

Scroll down the display and tick the windows to be part of the program ①.
Note: The individual products can be identified by tapping the icon. See also the section *Finding products*.
Tap ⇨ ②.

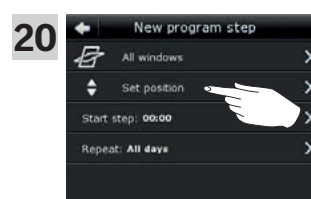

Tap "Set position".



Drag the slider or tap the bar to set the opening of the windows to 0%. The position from 0-100 is shown in the bottom right corner ①.
Tap ⇨ ②.

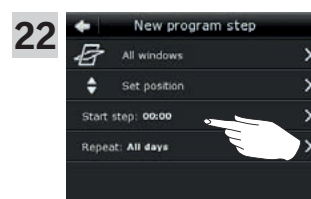

Tap "Start step: 00:00".

Operation

Programs - Own programs

2

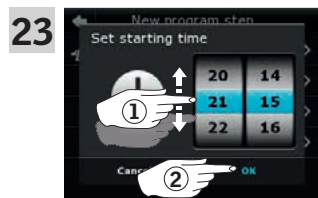

23 Roll the wheel to set the time to close the windows ①.
Tap "OK" ②.

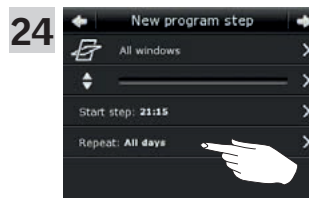

24 Tap "Repeat: All days".



25 Scroll down the display and remove tick for the days not to be part of the program ①.
Tap ⇨ ②.

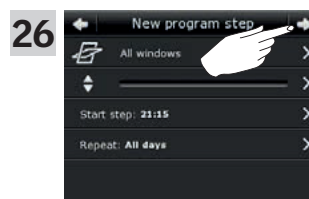

26 Tap ⇨.

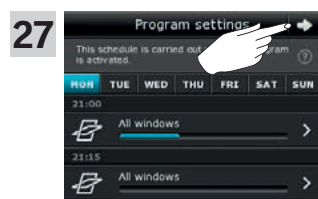

27 Tap ⇨.



28 Enter a name for the program, in this case "Night cooling" ①.
For use of keyboard, see the section *Keyboard*.
Tap ⇨ ②.



29 Tap "Start" to activate the program.

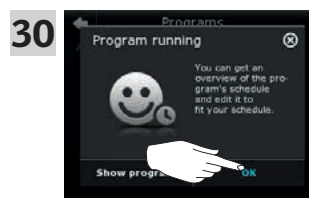

30 Tap "OK".

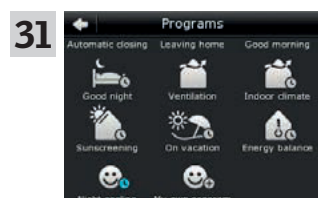

31 The program "Night cooling" is now in the program overview. From this overview you may start, stop and edit the program at any time. When you start it, the clock turns blue.

Operation

Programs - Own programs

2

Editing a program

You can change the settings in a program to make it better suit your requirements.

The example shows how to change the settings so that Window 3 is no longer part of the program "Night cooling".

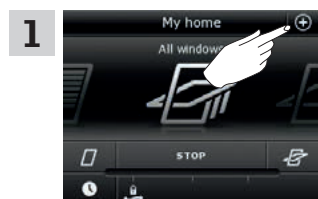

1 Tap ⊕.

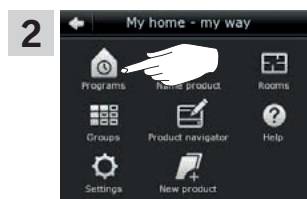

2 Tap "Programs".

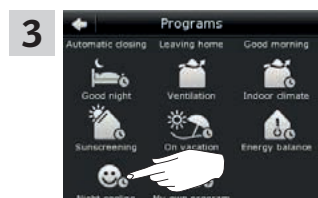

3 Tap "Night cooling".



4 Tap "Edit".

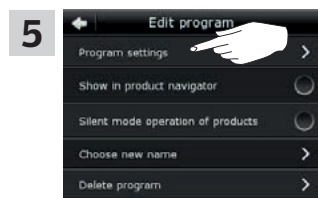

5 Tap "Program settings".

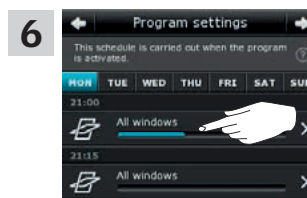

6 Tap "All windows".

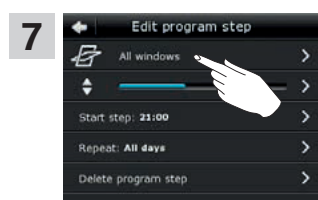

7 Tap "All windows".



8 Remove tick for the window not to be opened ①.
Note: The individual products can be identified by tapping the icon. See also the section *Finding products*. Tap ⇨ ②.

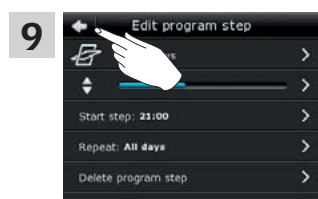

9 Tap ←.

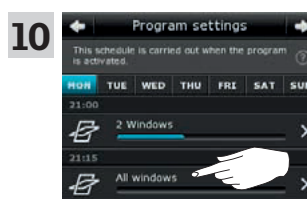

10 Tap "All windows".

Operation

Programs - Own programs

2

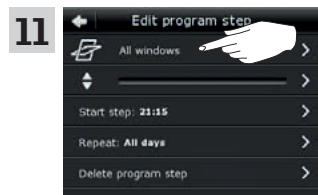

Tap "All windows".



Remove tick for the window not to be closed ①.

Note: The individual products can be identified by tapping the icon. See also the section *Finding products*.

Tap ⇨ ②.

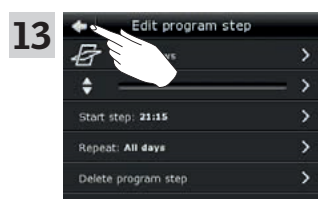

Tap ⇐.

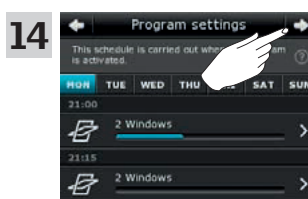

Tap ⇨.



Tap  to finish.

Operation

Programs - Own programs

2

Adding a program to the product navigator

You can place a program in the product navigator to make it easier for you to activate it.

The example shows how to add the program "Night cooling" to the product navigator.

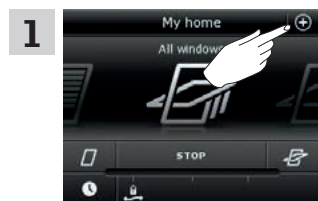

1 Tap ⊕.

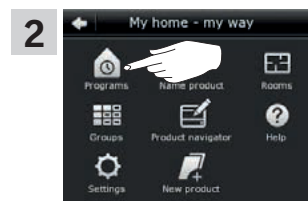

2 Tap "Programs".

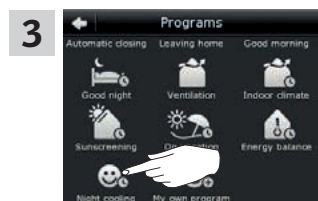

3 Tap "Night cooling".

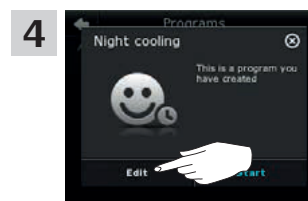

4 Tap "Edit".

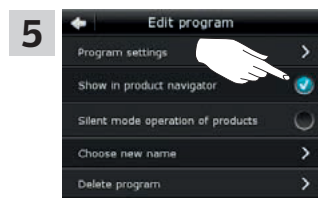

5 Tick "Show in product navigator".



6 Tap to finish.

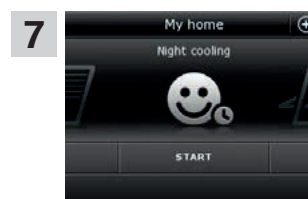

7 Now the program has been added to the product navigator where you can start and stop it.

Operation

Programs - Own programs

2

Renaming a program

You can rename your own programs.

In the example, the name of the program "Night cooling" is changed into "Night program".

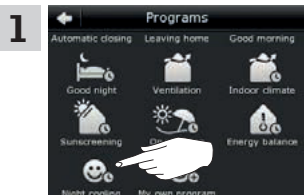

1 Tap "Night cooling".

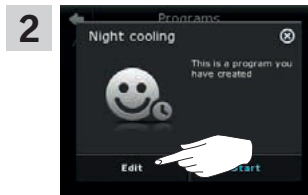

2 Tap "Edit".

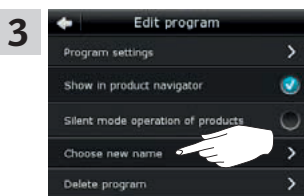

3 Tap "Choose new name".

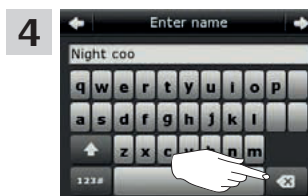

4 Tap **X** repeatedly to delete the present name. For use of keyboard, see the section *Keyboard*.

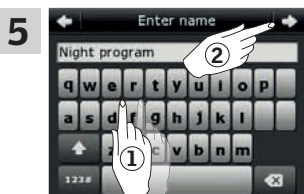

5 Enter a new name for the program, in this case "Night program" ①. Tap \Rightarrow ②.

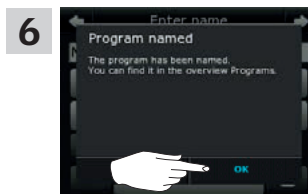

6 Tap "OK".



7 Tap \triangle to finish.

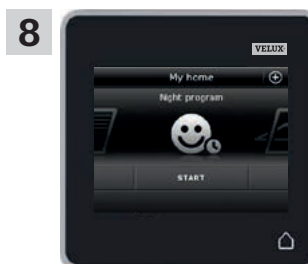

8 You can find the program with the new name in the product navigator.

Operation

Programs - Own programs

2

Silent mode operation

Some products have been set to silent mode operation when they are activated by programs running according to a schedule, see also the section *Using programs*. This may for instance be convenient if the products are activated automatically at night. Please note that products run slower when they have been set to silent mode operation. If you opt out of silent mode operation, the products will run faster.

The example shows how to deselect silent mode operation of products operated via the program "Night cooling".

- 1**

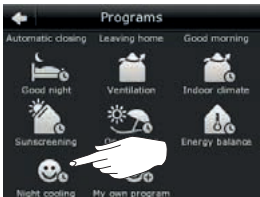

Tap "Night cooling".

2

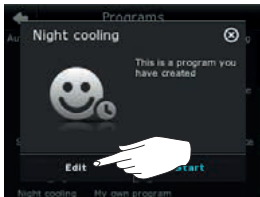

Tap "Edit".

- 3**

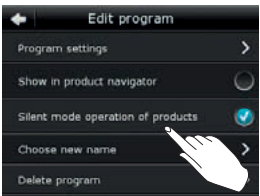

Remove the tick for "Silent mode operation of products".

4

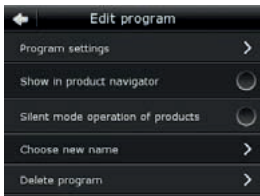

Silent mode operation has now been deselected.

- 5**



Tap to finish.

Deleting a program

If you do not want to use one of your own programs anymore, you can delete it.

The example shows how to delete the program "Night cooling".

- 1**



Tap "Night cooling".

2



Tap "Edit".

- 3**



Tap "Delete program".

4



Tap "Yes".

Finding products

It may be difficult to tell the products from each other in the product navigator. If you are in doubt you can identify the product of interest by tapping the icon for product, for instance at Window 3.

The example shows how to find Window 3 if for instance you are renaming the window.



1 Tap for "Window 3".



2 Tap "Show".



3 Window 3 will now run briefly back and forwards so you can see whether you found the right one or not. Tap "Window 3". You can now continue renaming the window or finding another product.

Keyboard

To change the names created automatically, you can enter new names via the keyboard. The keyboard is only visible when it is possible to use it.

Keyboard functions:



Switching between lower and upper case letters and between figures and special characters.

Switching between letters and figures.

Deleting the latest entered character.

The example shows how to use the keyboard, for instance when you are renaming groups and want to call a group "Group 1".



1 Enter "Group"
2 Tap "123#" to switch to figures

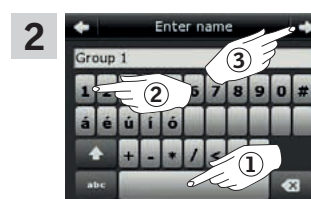

1 Tap the space bar
2 Enter "1"
3 Tap => to continue

Renaming products

You can change the names of products to make it easier to find and operate them.

The example shows how to change the names of Window 4 and Window 5 into Left and Right respectively.

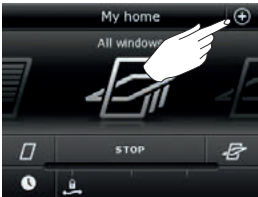
- 1** 

Tap ⊕.

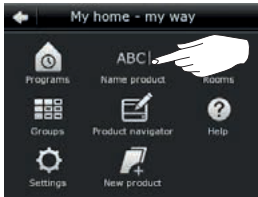
2 

Tap "Name product".

- 3** 

Tap "Window 4" ①.
Note: The individual products can be identified by tapping the icon. See also the section *Finding products*.
Tap ⇒ ②.

4 

Scroll down the display to find a name for the product on the list.
Note: You can also enter a name of your own by tapping "Enter name". For use of keyboard, see the section *Keyboard*.

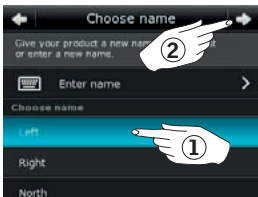
- 5** 

Select "Left" ①.
Tap ⇒ ②.

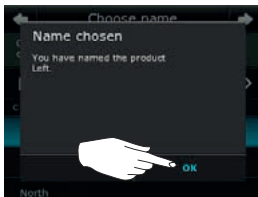
6 

Tap "OK".

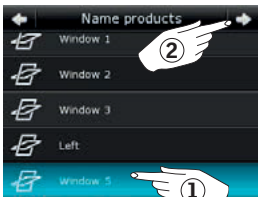
- 7** 

Tap "Window 5" ①.
Tap ⇒ ②.

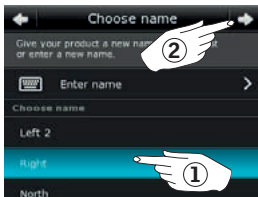
8 

Select "Right" ①.
Tap ⇒ ②.

- 9** 

Tap "OK".

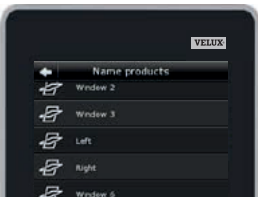
- 10** 

Tap to finish.

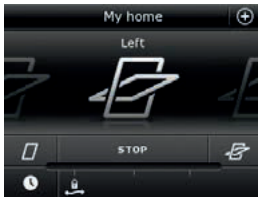
11 





The windows are now called "Left" and "Right" in the product navigator.

Creating a group

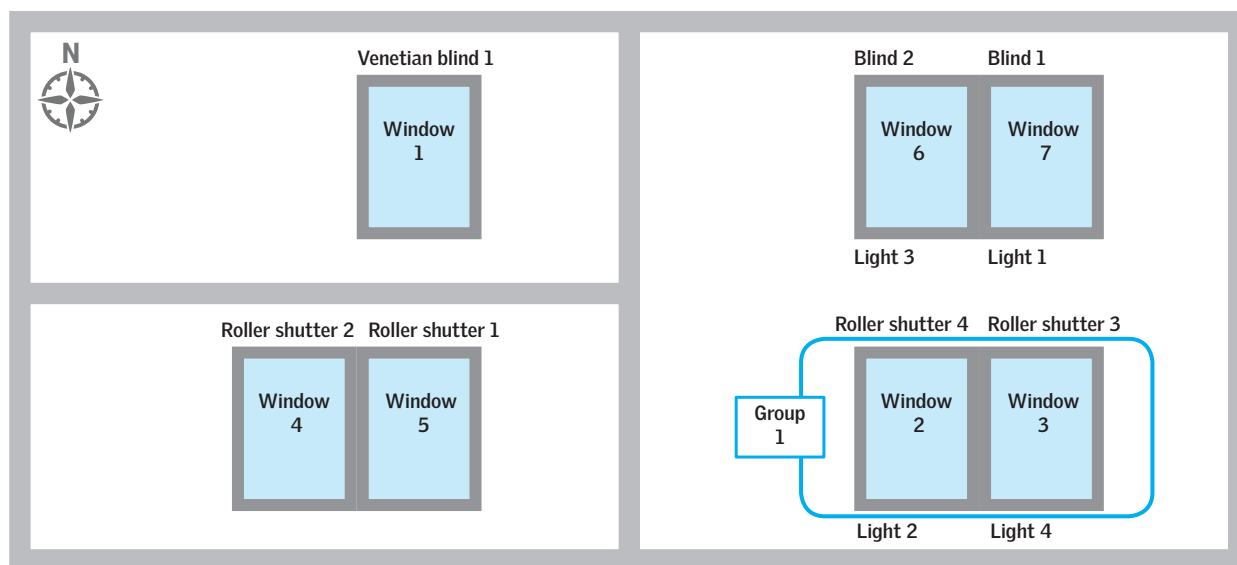
If you have several products of the same type, you can operate them simultaneously by grouping them. For instance, you can open and close all windows facing south or all windows in a room at the tap on a button.

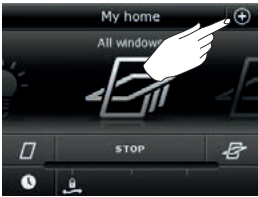
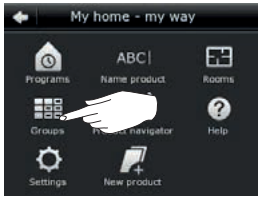
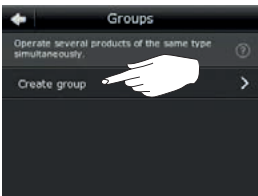
The example shows how to create the group "Group 1" containing Window 2 and Window 3.

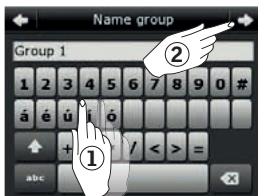

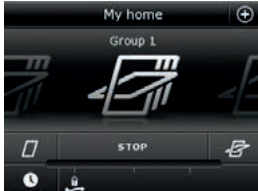
- 1**  Tap ⊕.
- 2**  Tap "Groups".
- 3**  Tap "Create group".
- 4**  Tap "Windows" ①.
Tap ⇒ ②.
- 5**  Scroll down the display and tick the windows to be included in the group ①.
Note: The individual products can be identified by tapping the icon. See also the section *Finding products*.
Tap ⇒ ②.
- 6**  Enter a name for the group, in this case "Group 1" ①.
For use of keyboard, see the section *Keyboard*.
Tap ⇒ ②.
- 7**  Tap "Operate group" to finish.
Note: Tap "Create more" to create more settings.
- 8**  You can find the group "Group 1" in the product navigator.

Editing a group

You can change the contents of a group by adding or removing products.

The example shows how to add Window 4 and Window 5 to the group "Group 1" already consisting of Window 2 and Window 3.

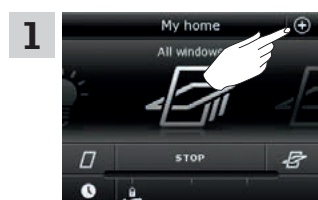
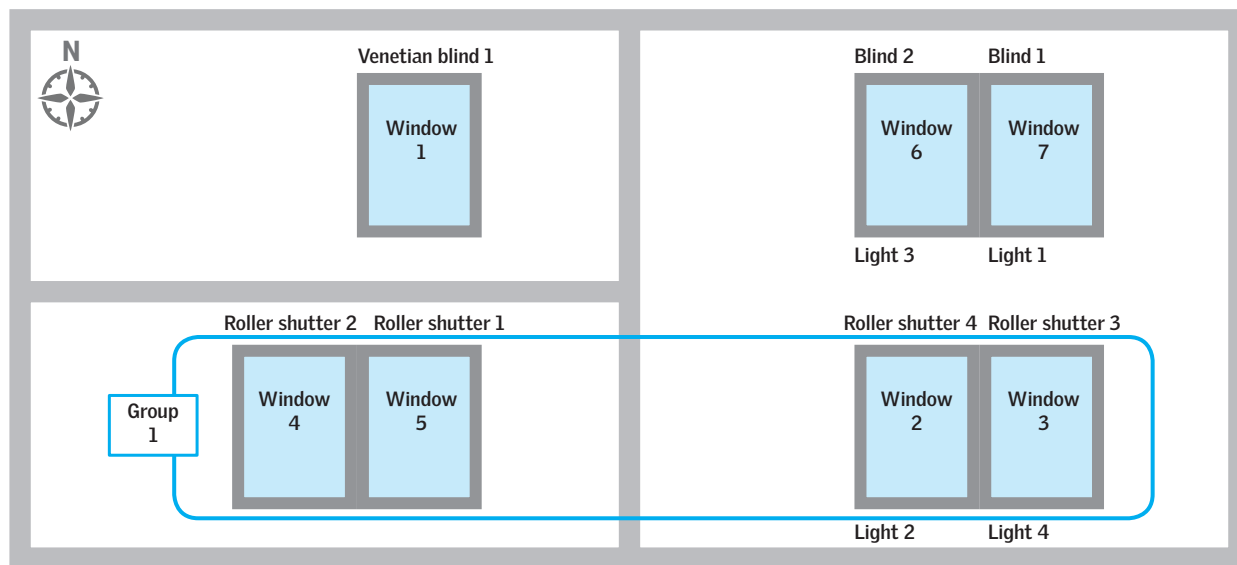

1 Tap ⊕.

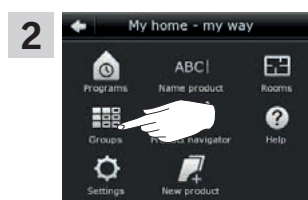

2 Tap "Groups".

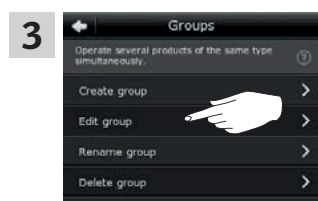

3 Tap "Edit group".



4 Tap "Group 1" ①.
Tap ⇨ ②.

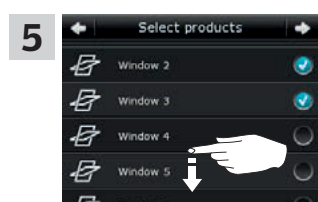

5 Scroll down the display to find the relevant windows.
Note: The individual products can be identified by tapping the icon. See also the section *Finding products*.

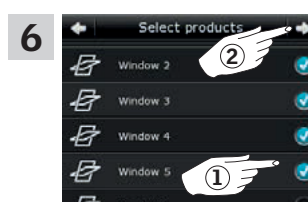

6 Tick the windows to be added to the group ①.
Note: Products can similarly be removed from a group by removing the tick.
Tap ⇨ ②.



7 Tap "Operate group" to finish.
Note: Tap "Edit more" to create more settings.

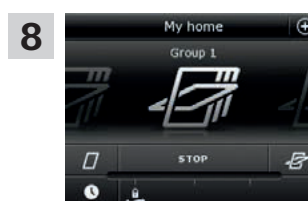

8 You can find the group "Group 1" containing the additional products in the product navigator.

Operation
Smart operation - Groups

2

Renaming a group

You can change the name of a group.

The example shows how to change the name "Group 1" into "South windows".

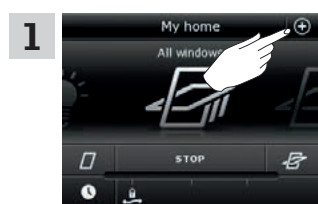

Tap ⊕.

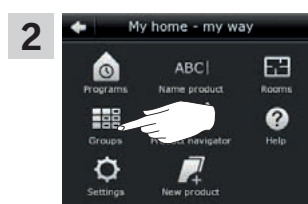

Tap "Groups".

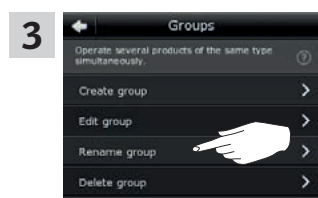

Tap "Rename group".

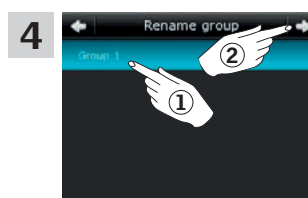

Tap "Group 1" ①.
Tap ⇒ ②.



Enter a name for the group, in this case "South windows" ①.
For use of keyboard, see the section *Keyboard*.
Tap ⇒ ②.

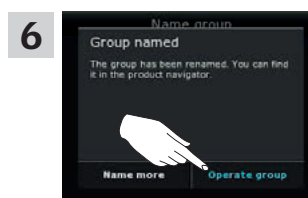

Tap "Operate group" to finish.
Note: Tap "Name more" to create more settings.

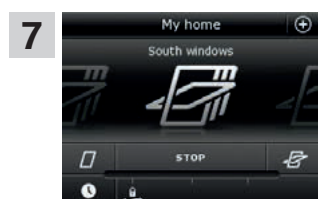

The group is now called "South windows" in the product navigator.

Operation
Smart operation - Groups

2

Deleting a group

You can delete a group if it is not relevant anymore.

The example shows how to delete the group "South windows".

Note: Only the group is deleted. You can still operate the products individually via the product navigator.

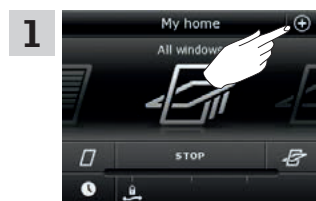

Tap ⊕.

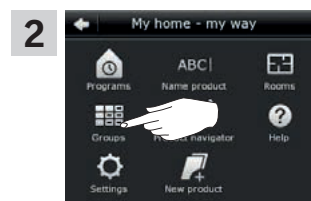

Tap "Groups".

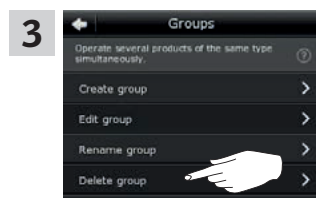

Tap "Delete group".

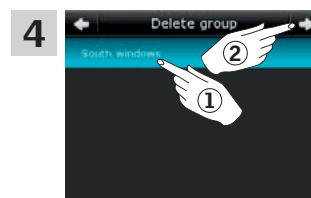

Tap the group to be deleted, in this case "South windows" ①.
Tap ⇒ ②.

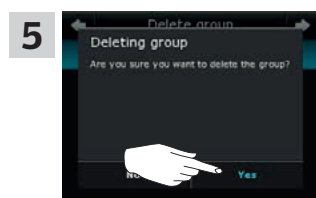

Tap "Yes".



Tap ⏠ to finish.

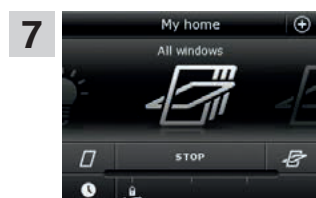

The group "South windows" is not in the product navigator anymore.
However, you can still operate the products individually via the product navigator.

Operation
Smart operation - Rooms

2

Creating a room

You can create rooms corresponding to the actual rooms in your home, and put your VELUX products in them. This makes it easier to find and operate the right products.

The example shows how to create the room "Bedroom" including Window 4 and Window 5 in it.

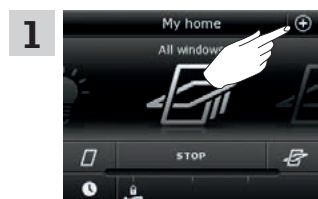
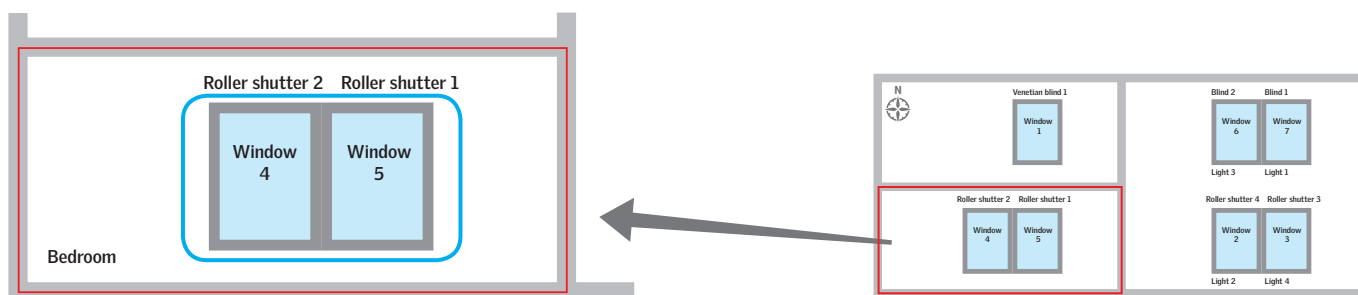

1 Tap ⊕.



2 Tap "Rooms".

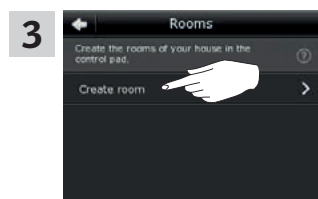

3 Tap "Create room".

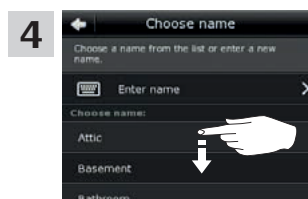

4 Scroll down the display to find a name for the room on the list. **Note:** You can also enter a name of your own by tapping "Enter name". For use of keyboard, see the section *Keyboard*.

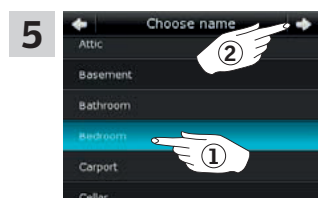

5 Select "Bedroom" ①. Tap ⇒ ②.

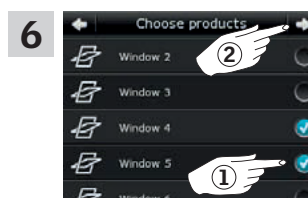

6 Scroll down the display and tick the windows in the room ①. **Note:** The individual products can be identified by tapping the icon. See also the section *Finding products*. Tap ⇒ ②.

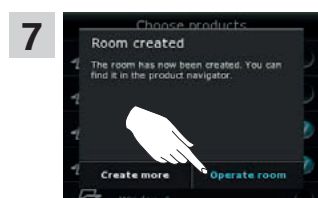

7 Tap "Operate room" to finish. **Note:** Tap "Create more" to create more settings.

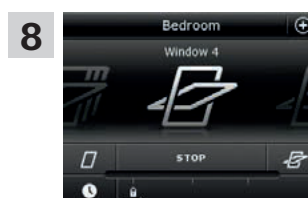

8 You can now find the room "Bedroom" in the product navigator.

Editing a room

You can change the contents of a room by adding or removing products.

The example shows how to add Roller shutter 2 and Roller shutter 1 to the room "Bedroom" already consisting of Window 4 and Window 5.

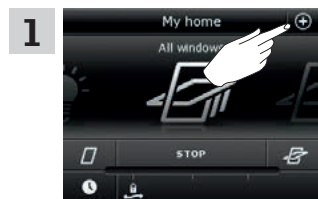
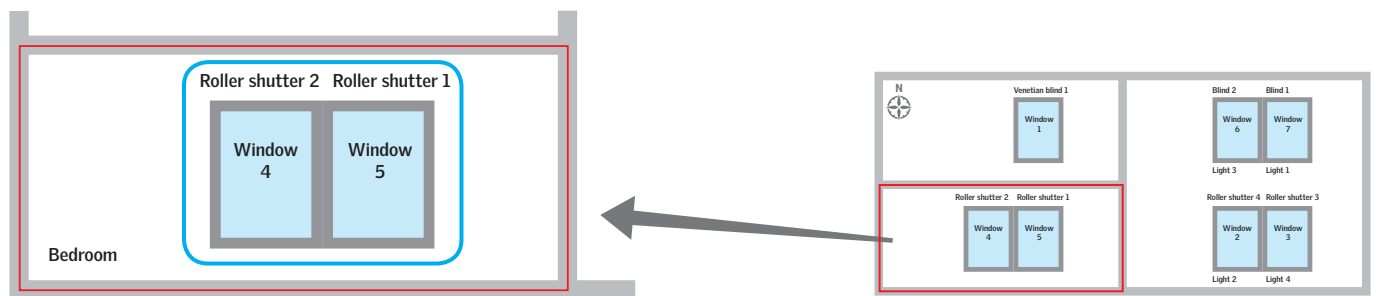

1 Tap ⊕.

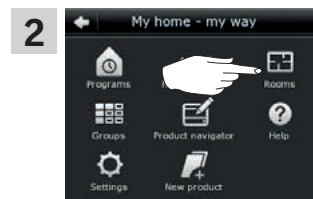

2 Tap "Rooms".

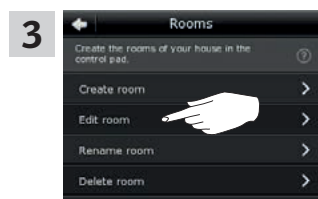

3 Tap "Edit room".

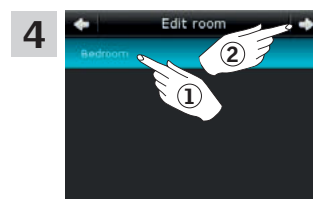

4 Tap "Bedroom" ①.
Tap ⇒ ②.



5 Scroll down the display to find the roller shutters in the room.
Note: The individual products can be identified by tapping the icon. See also the section *Finding products*.

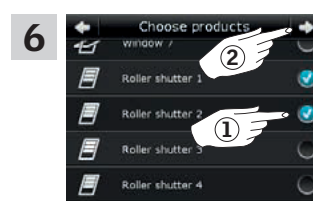

6 Tick the roller shutters to be added to the room ①.
Note: Products can similarly be removed from a room by removing the tick.
Tap ⇒ ②.

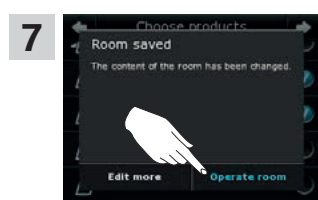

7 Tap "Operate room" to finish.
Note: Tap "Edit more" to create more settings.

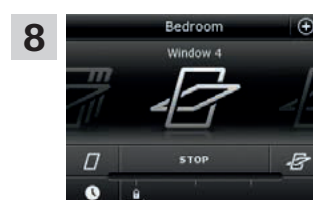

8 You can now see the changed contents of the room "Bedroom" in the product navigator.

Renaming a room

You can change the name of a room.

The example shows how to change the name "Bedroom" into "Child's room".

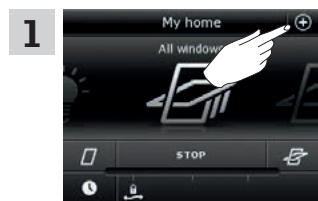

1 Tap ⊕.

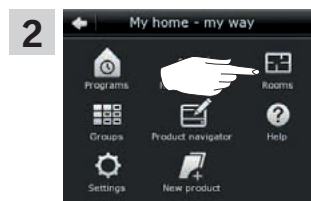

2 Tap "Rooms".

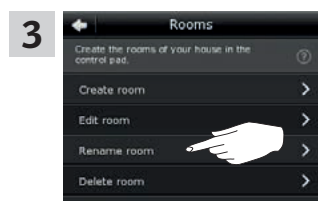

3 Tap "Rename room".

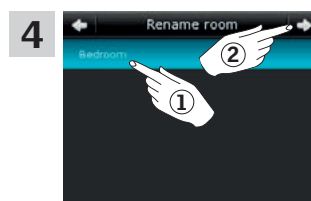

4 Tap "Bedroom" ①.
Tap ⇒ ②.

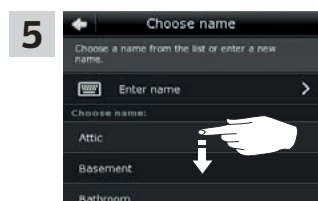

5 Scroll down the display to find a name for the room on the list.
Note: You can also enter a name of your own by tapping "Enter name". For use of keyboard, see the section *Keyboard*.

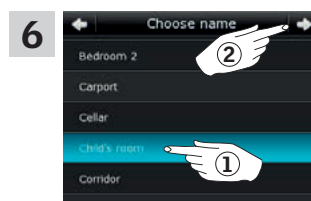

6 Select "Child's room" ①.
Tap ⇒ ②.

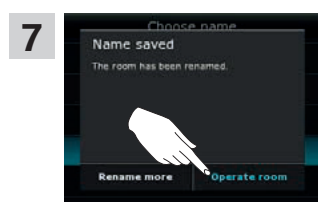

7 Tap "Operate room" to finish.
Note: Tap "Rename more" to create more settings.



8 The room is now called "Child's room" in the product navigator.

Deleting a room

You can delete a room if it is not relevant anymore.
The example shows how to delete the room "Child's room".

Note: Only the room is deleted. You can still operate the products individually via the product navigator.

- Tap ⊕.
- Tap "Rooms".
- Tap "Delete room".
- Tap the room to be deleted, in this case "Child's room" ①.
Tap ⇒ ②.
- Tap "Yes".
- Tap ⏠ to finish.
- The room "Child's room" is not in the product navigator anymore.
However, you can still operate the products individually via the product navigator.

Operation

Smart operation - Favourites

2

Editing order of products in the product navigator

If you use some products, groups or programs more often than others, it may be convenient to show them in another order in the product navigator.

The example shows how to put the products Window 4 and Window 5 first in the product navigator.

- Tap ⊕.
- Tap "Product navigator".
- Tap "Order of products".
- Scroll down the display to find the relevant product, in this case "Window 4".
Note: The individual products can be identified by tapping the icon. See also the section *Finding products*.
- Tap ≡.
- Tap ▲ three consecutive times to put Window 4 in front of Window 1.
- Scroll down the display to find the relevant product, in this case "Window 5".
Note: The individual products can be identified by tapping the icon. See also the section *Finding products*.
- Complete the actions in items 5 and 6 for Window 5 to put it beneath Window 4.
- Tap ⇒.
- Tap "OK".
- Tap ◻ to finish.
- Window 4 and Window 5 are now at the top of the product navigator.

Operation
Smart operation - Favourites

2

Editing favourites

When activating the function "Favourites", the product navigator only shows the products, groups and/or programs you use most often. You can at any time choose to see all your products, groups and/or programs again.

The example shows how to choose Window 1, Roller shutter 1 and Venetian blind 1 as favourites. In consequence, these products will be the only ones shown in the product navigator. This may be convenient if the control pad is only to be used in the room where these products are located.

- Tap ⊕.
- Tap "Product navigator".
- Tap "Favourites".
- Tap "Edit favourites".
- As default all products have been chosen as favourites. Remove the tick for all products not to be favourites.
Note: The individual products can be identified by tapping the icon. See also the section *Finding products*.
- Tap ⇌ when only the products to be favourites remain ticked, in this case Window 1, Roller shutter 1 and Venetian blind 1.
- Tap "OK".
- Tap ⏠ to finish.
- The product navigator now shows the three chosen products only.
- To be able to see all products again, you must remove the tick for "Show favourites" in item 8.

Operation

Operation without using the control pad

2

Manual operation of centre-pivot windows

You can open and close your centre-pivot window manually.

If the window is already open, you must close it fully via the control pad first.

- Open the window by pulling downwards on the control bar of the window.
- Close the window again by pushing the control bar back again.

Note: If you have opened the window manually, you must also close it manually to be able to operate it with the control pad again. This also applies to making the programs run and the window close automatically in case of rain.

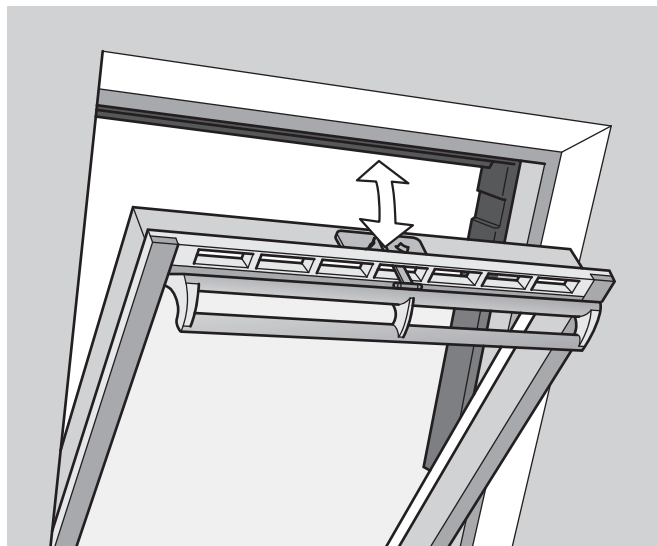

Operation

Operation without using the control pad

2

Closing centre-pivot windows in case of power failure or discharged battery

In case of power failure or discharged battery, you can close your centre-pivot window manually by disengaging the chain on the ventilation flap of the window.

There are two different ways of doing this, depending on window type, where the ventilation flap can look like **A** or **B**. See below on how to disengage the chain on the ventilation flap according to your window type.

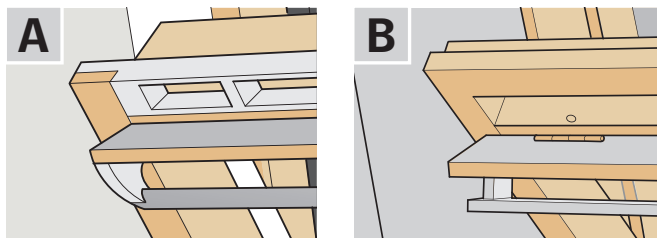

A

The ventilation flap of the window looks like **A**:

- 1 Disengage the chain by pressing the release clip on the flap bracket.
- 2 Remove the flap bracket.
- 3 Fold the chain as shown, and close the ventilation flap of the window to ventilation position.

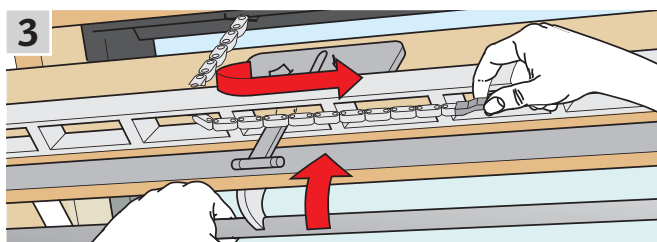
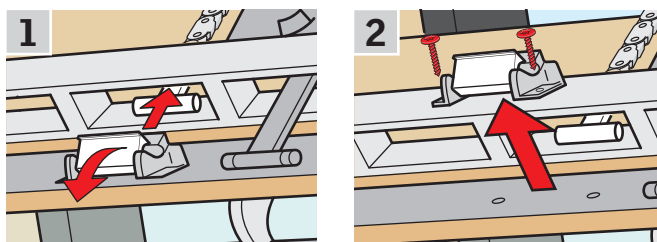

B

The ventilation flap of the window looks like **B**:

- 1 Disengage the chain by pressing the release clip on the flap bracket.
- 2 Fold the chain as shown, and close the window manually.

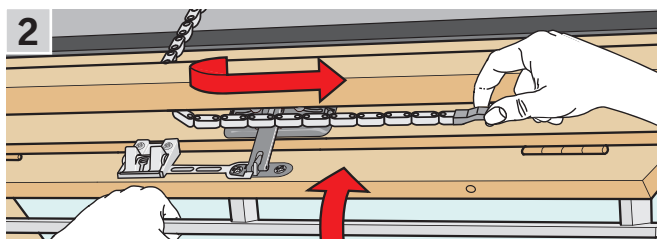
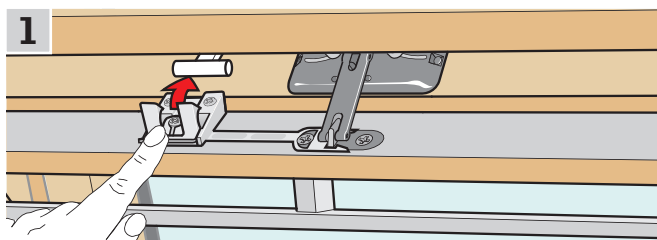

When the power has been reconnected or the battery has been recharged, you must re-engage the chain.

- Open the window manually and unfold the chain.
- Replace the flap bracket if the ventilation flap looks like **A**.
- Run back the chain by pressing the test button on the window operator briefly.
- Close the window manually.

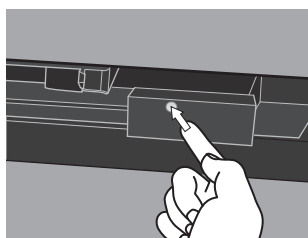

Operation

Operation without using the control pad

2

Closing windows if the control pad has been mislaid

If your control pad has been mislaid, you can still close your window by carrying out the following actions.

Note: This feature is only available for the products shown.

Centre-pivot windows

- 1 Determine window type **A** or **B** as shown on the previous page. Disengage the chain according to window type.
- 2 Press the test button on the window operator briefly. Wait until the chain stops moving then close the window manually.

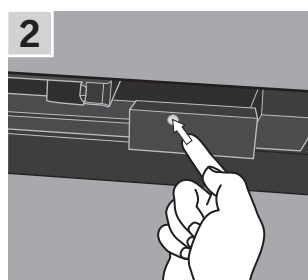
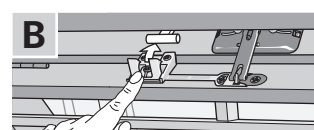
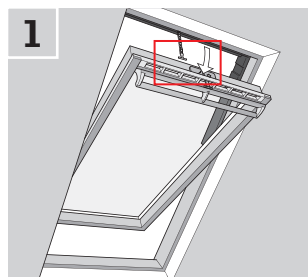

Flat roof windows

- 1 Carefully remove the cover cap on the kerb.
- 2 Press the test button on the window operator behind the cover cap briefly and refit the cover cap.

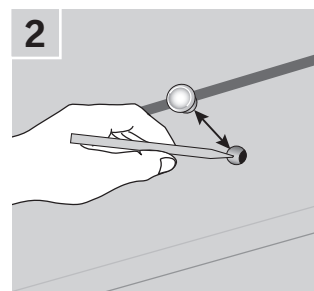
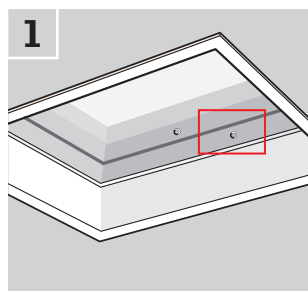

Top-hung windows

- 1 Remove the cover of the window operator.
- 2 Press the test button on the window operator briefly and refit the cover.

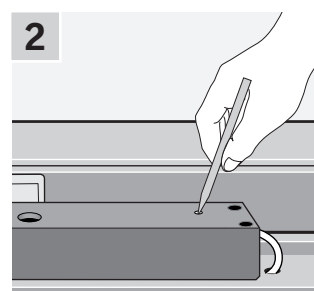
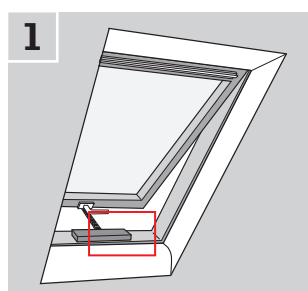

Setting up
Start-up of a new VELUX INTEGRA® system

3

Initial set-up

Before you can operate your VELUX INTEGRA® products, they must be registered in the control pad.

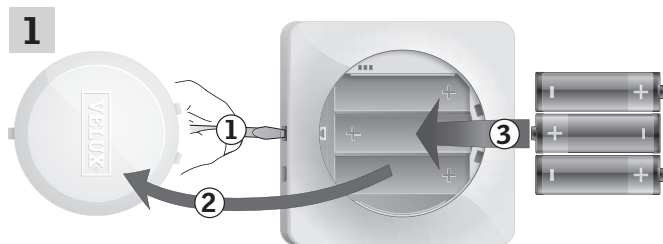

Remove the battery compartment lid by pressing the release button with a screwdriver as illustrated ①, ②. Insert batteries (type AA/LR6) ③. Replace lid.



In the display screen, roll the wheel in the directions of the arrows to choose language ①. Tap ⇒ ②.

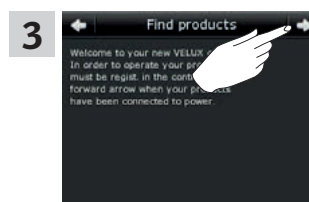

Follow the instructions in the display, and tap ⇒ when you are ready.

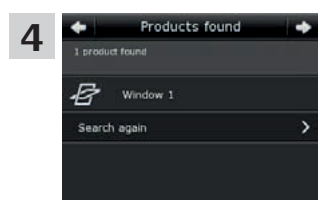

Tap ⇒ when the control pad has found **all** products.
Note: Tap "Search again" if the control pad did **not** find **all** products and follow the instructions in the display. Go to the section *If the initial set-up fails* if the control pad still cannot find all products even if they are connected to power.

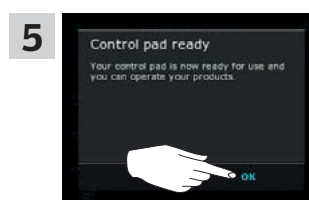

Tap "OK".

If the initial set-up fails

If the control pad cannot find some of the products, you can make the products ready for registration by manually resetting them to their initial factory settings.

Note: Reset products cannot be operated until they have been registered in the control pad. See the section *Initial set-up*.

Products can be reset in different ways, depending on window type.

Note: Contact your local VELUX sales company for reset of products not shown.

Centre-pivot windows

- 1 Open window manually (if the window is already open, close it by pressing the test button on the window operator).
- 2 Press the test button on the window operator for at least 10 seconds.
The window operator and other electrical products on the window will run briefly back and forth. Frame lights, if installed, will flash briefly.

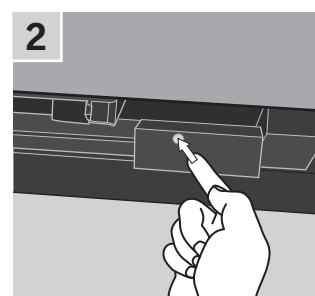
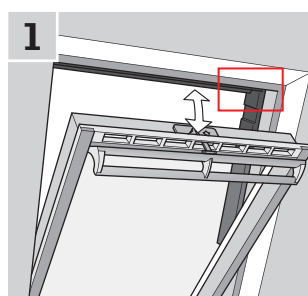

Flat roof windows

- 1 Carefully remove the cover cap on the kerb.
- 2 Press the test button on the window operator behind the cover cap for at least 10 seconds.
The window operator and other electrical products on the window will run briefly back and forth. Refit cover cap.

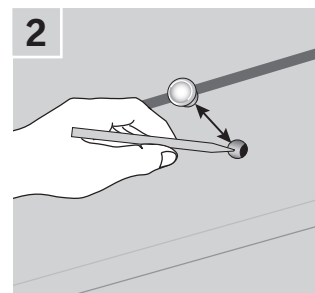
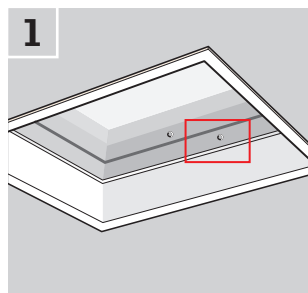

Modular skylights

- 1 Remove bottom flashing section from the modular skylight and unscrew the small, right-hand cover of the control unit.
- 2 Press the reset button in the control unit for 6-10 seconds.
Screw on the cover again and refit bottom flashing section.

Note: As registration in the control pad must take place within 10 minutes, you are advised to register the products before refitting bottom flashing section.

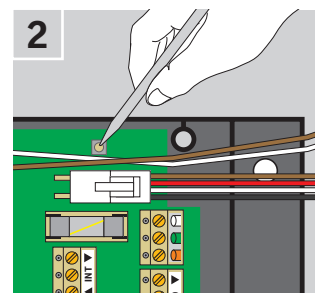
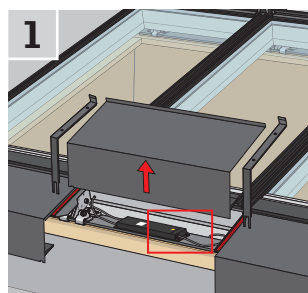

Adding products to the control pad

You can operate up to 200 products, for instance windows, roller shutters and blinds, by registering them in your control pad. The example shows how to add more products to the control pad by following the instructions in the display.

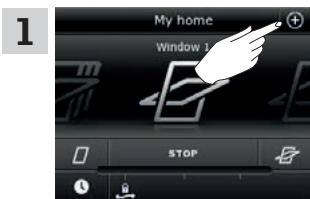

1 Tap ⊕.

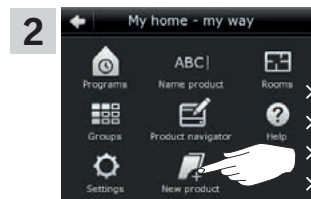

2 Tap "New product".

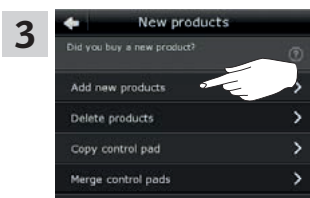

3 Tap "Add new products".



4 Tap ⇨.



5 Tap ⇨ when the control pad has found the products. You can now operate the new products.

Setting up

Extension of your VELUX INTEGRA® system - Adding a control

Adding a control to your system already operated with a VELUX INTEGRA® control pad KLR 200

"Control" is used as a generic term for all devices that can operate VELUX INTEGRA® products.

To operate your VELUX INTEGRA® products with additional controls, the contents of the control pad KLR 200 already in use can be copied to other controls.

Note: If you have edited the standard programs or made your own programs, these are not copied to the additional control.

To find the control you want to add to your system, please see the page references below.



VELUX INTEGRA®
control pad KLR 200
(3LR A02)
Pages 42-43



VELUX INTEGRA®
controller KRX 100
(3LF D02)
Pages 44-46

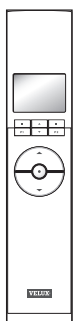

VELUX INTEGRA®
remote control without display
(3UR B01)
Page 47

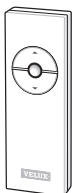

VELUX INTEGRA®
control switch KLI 110
(3LI D01)
Page 48



VELUX INTEGRA®
interface KLF 050 fitted
into a wall switch/socket
of another make
(3LF D50)
Page 49

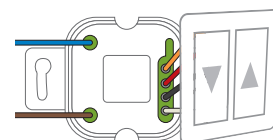

VELUX INTEGRA®
interface KLF 100
(3LF D01)
Pages 50-51

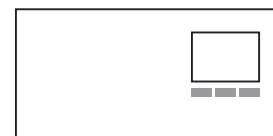

Other types of io-homecontrol®
controls
Pages 52-53



Setting up

Extension of your VELUX INTEGRA® system - Adding a control

3

Adding a VELUX INTEGRA® control pad KLR 200 to your system already operated with a control pad KLR 200

The instructions below show how to copy the contents of one control pad KLR 200 to another.

Control pad KLR 200 to **send** a copy is called control **A**.
Control pad KLR 200 to **receive** a copy is called control **B**.

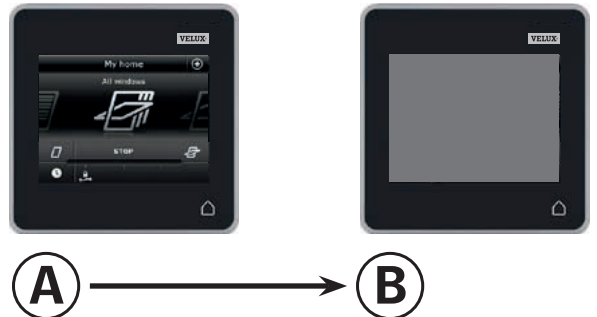

First execute items 1-4 with **B**.

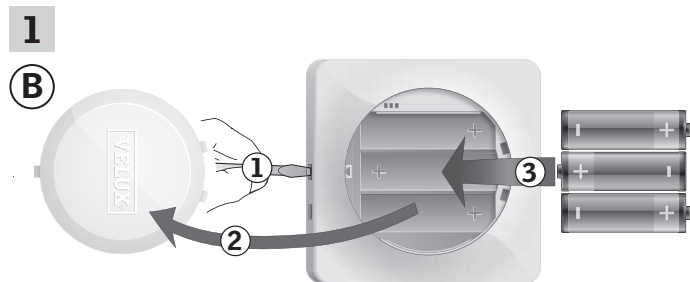

Remove the battery compartment lid by pressing the release button with a screwdriver as illustrated ①, ②.
Insert batteries (type AA/LR6) ③.
Replace lid.



In the display screen, roll the wheel in the directions of the arrows to choose language ①. Tap ⇒ ②.

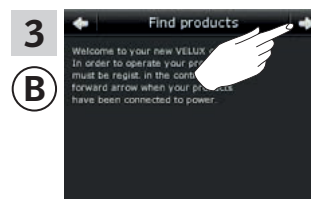

Follow the instructions in the display and tap ⇒ when you are ready.

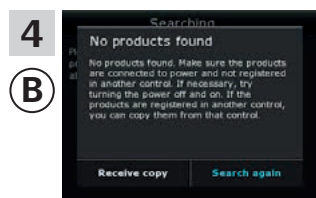

Do **not** tap "Receive copy" until item 9.

Setting up

Extension of your VELUX INTEGRA® system - Adding a control

3

Now execute items 5-8 with (A).

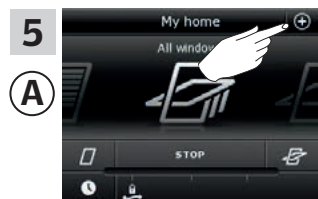

Tap ⊕.

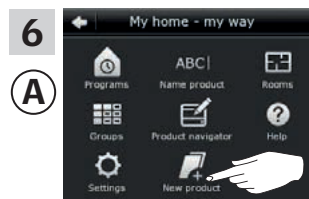

Tap "New product".



Tap "Copy control pad".

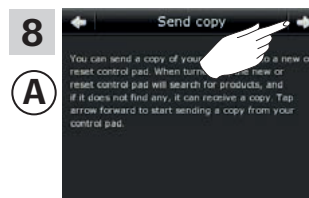

Tap ⇒.

You now have two minutes to execute item 9 with (B).

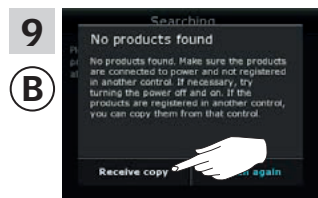

Tap "Receive copy".
Follow the instructions in the display and tap ⇒ when you are ready.

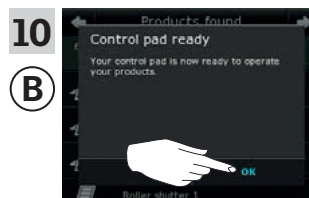

Tap "OK".



Tap ◀ on both control pads to finish.

Setting up

Extension of your VELUX INTEGRA® system - Adding a control

3

Adding a VELUX INTEGRA® controller KRX 100 to your system already operated with a control pad KLR 200

The instructions below show how to copy the contents of control pad KLR 200 to controller KRX 100. See also the instructions for the controller.

Note: Only available for VELUX INTEGRA® products with radio frequency 868 MHz.

Control pad KLR 200 to **send** a copy is called control (A).
Controller KRX 100 to **receive** a copy is called control (B).

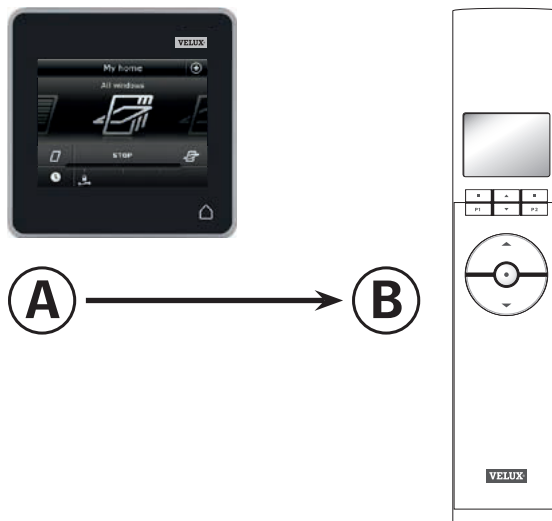

First execute items 1-3 with (B).

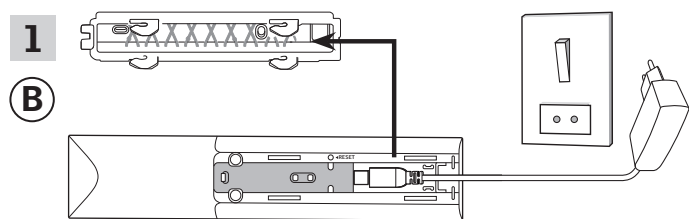

Connect to mains supply:
Remove the back cover of the controller as shown. Click the adaptor plug into the controller and replace the cover. Connect the adaptor to mains supply.

Note: The controller saves the selected settings even if the mains supply is disconnected. Therefore, it is advisable not to fit the controller permanently until the sunscreening products and the sensors have been registered in the controller. However, time and date are only saved for 30 seconds after disconnection of mains supply.

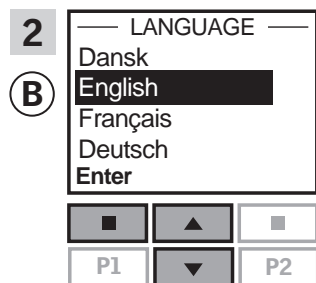

2 Select language:
Press to highlight your language.
Press "Enter" to confirm your choice.

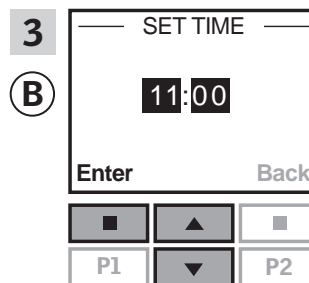

3 Set time:
Press to set minutes.
Press "Enter" to change to hours.
Press to set hours.
Press "Enter" to confirm your settings.

Setting up

Extension of your VELUX INTEGRA® system - Adding a control

3

Prepare sensors and register them in the controller.

Note: You have 10 minutes to execute items 4-8.

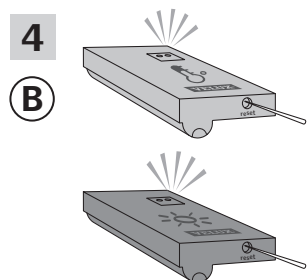

4 Prepare sensors for registration: Press the button at the bottom of the sensor with a pointed object for at least 5 seconds until the diode flashes.

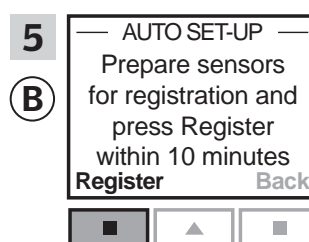

5 Register sensors in the controller: Press "Register" to register the two sensors.

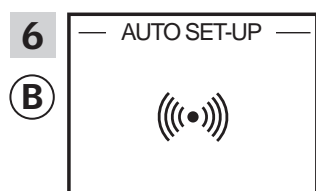

6 Registration is running. This may take several minutes.

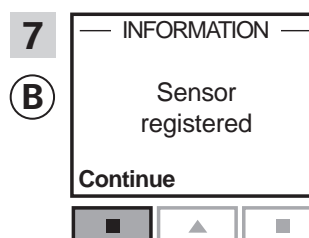

7 The display shows "Sensor registered" when the sensors have been registered. Press "Continue" to proceed.

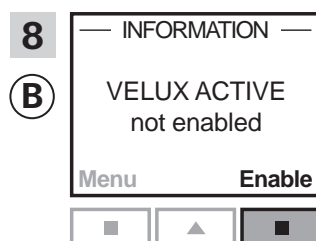

8 The display shows that the program VELUX ACTIVE has not been enabled. Press "Enable" to start registration of sunscreening products in the controller.



9 Do **not** press "Register" until item 14.

Execute items 10-13 with .

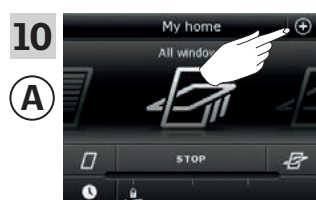

10 Tap .

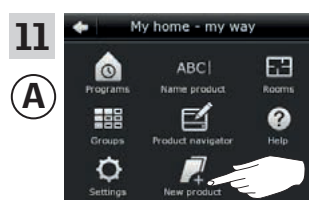

11 Tap "New product".

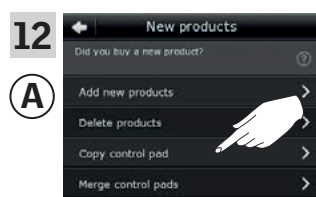

12 Tap "Copy control pad".

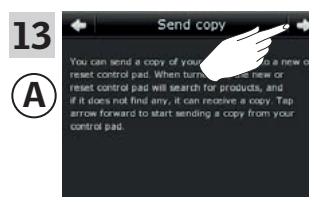

13 Tap .

Continue on the next page

Setting up

Extension of your VELUX INTEGRA® system - Adding a control

You now have two minutes to execute item 14 with Ⓑ.



Press "Register" in the controller to start registration.

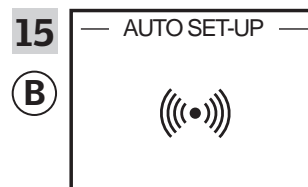

Registration is running. This may take several minutes.

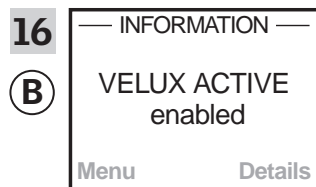

The display shows that the program VELUX ACTIVE has been enabled.
If the display shows that the program VELUX ACTIVE has not been enabled, please refer to the section *Initial set-up, Interior sunscreening products* in the instructions for the controller.

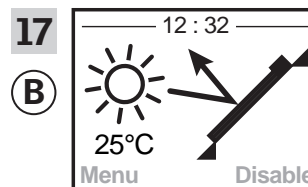

The display shows the program mode including current temperature and time.



Tap to finish.

Setting up

Extension of your VELUX INTEGRA® system - Adding a control

3

Adding a VELUX INTEGRA® remote control without display to your system already operated with a control pad KLR 200

The instructions below show how to copy the contents of control pad KLR 200 to the remote control without display. See also the instructions for the remote control.

Note: Only available for VELUX INTEGRA® products with radio frequency 868 MHz.

Control pad KLR 200 to **send** a copy is called control **A**.
The remote control without display to **receive** a copy is called control **B**.

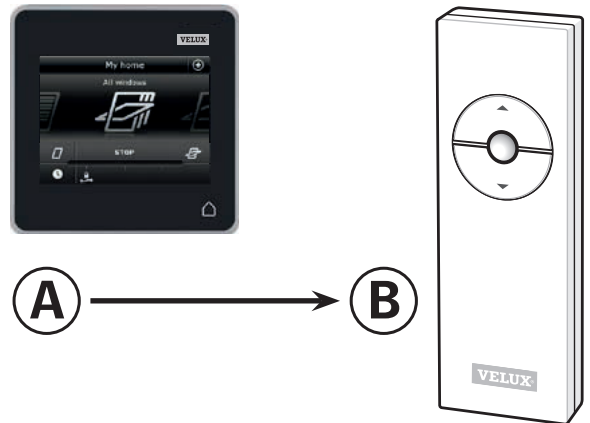

First execute items 1-5 with **A**.

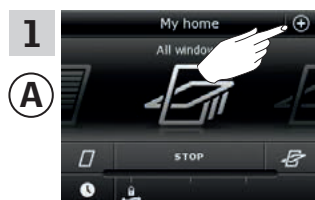

Tap ⊕.

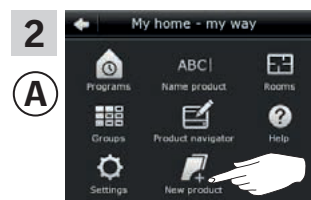

Tap "New product".

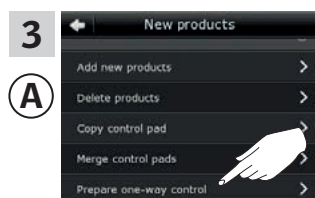

Tap "Prepare one-way control".

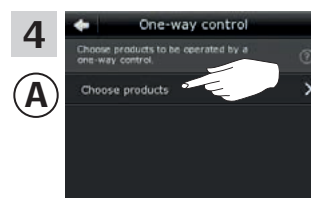

Tap "Choose products".

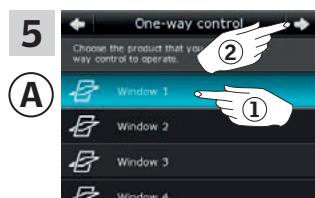

Scroll down the display and choose the product to be added ①. **Note:** individual products can be identified by tapping the icon. See also the section *Finding products*. Tap ⇒ ②.

You now have 10 minutes to execute item 6 with **B**.

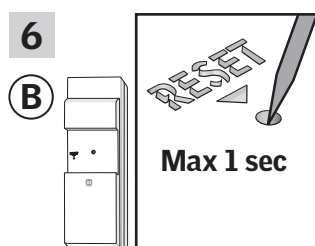

Press briefly the RESET button on the back with a pointed object to register the new product. You can now operate the chosen product with **B**.



Tap ⏠ to finish. **Note:** To add more products, tap "Choose more" and repeat items 5-7.

Setting up

Extension of your VELUX INTEGRA® system - Adding a control

3

Adding a VELUX INTEGRA® control switch KLI 110 to your system already operated with a control pad KLR 200

The instructions below show how to copy the contents of control pad KLR 200 to control switch KLI 110. See also the instructions for the control switch.

Control pad KLR 200 to **send** a copy is called control ①.
Control switch KLI 110 to **receive** a copy is called control ②.

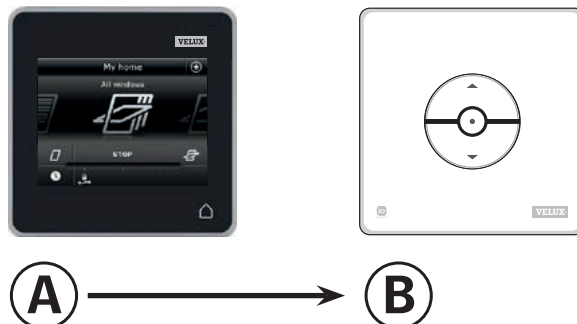

First execute items 1-5 with ①.

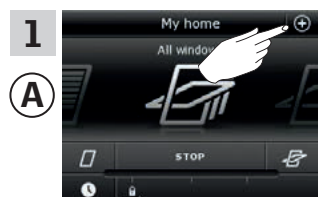

Tap ⊕.

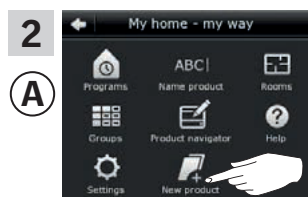

Tap "New product".

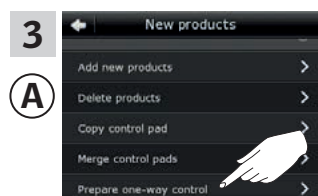

Tap "Prepare one-way control".

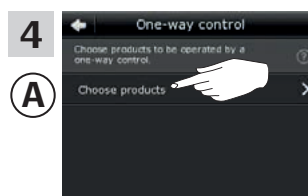

Tap "Choose products".

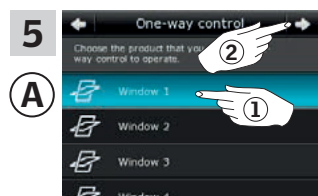

Scroll down the display and choose the product to be added ①.
Note: individual products can be identified by tapping the icon. See also section *Find products*.
Tap ⇒ ②.

You now have 10 minutes to execute item 6 with ②.

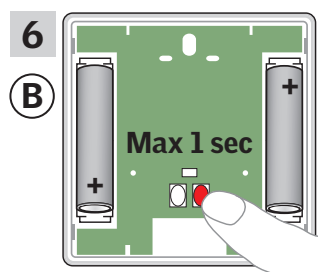

Press briefly the RESET button on the back to register the new product.
You can now operate the chosen product with ②.



Tap ⏠ to finish.
Note: To add more products, tap "Choose more" and repeat items 5-7.

Setting up

Extension of your VELUX INTEGRA® system - Adding a control

3

Adding a VELUX INTEGRA® interface KLF 050, which is fitted into a wall switch/socket of another make, to your system already operated with a control pad KLR 200

The instructions below show how to copy the contents of control pad KLR 200 to interface KLF 050 fitted into a wall switch/socket of another make. See also the instructions for the interface.

Note: Only available for VELUX INTEGRA® products with radio frequency 868 MHz.

Control pad KLR 200 to **send** a copy is called control (A).
Interface KLF 050 to **receive** a copy is called control (B).

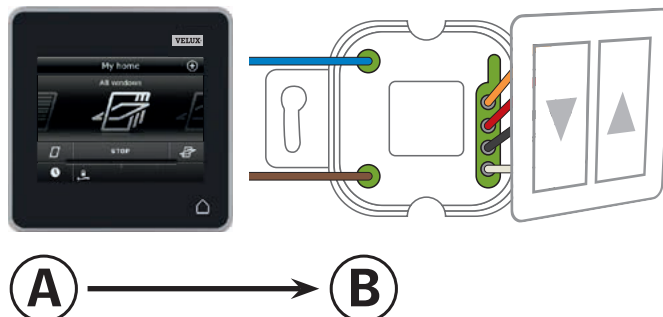

First execute items 1-5 with (A).

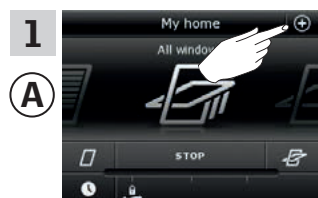

Tap ⊕.

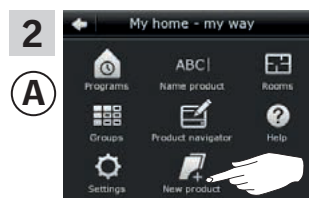

Tap "New product".

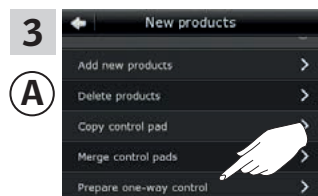

Tap "Prepare one-way control".

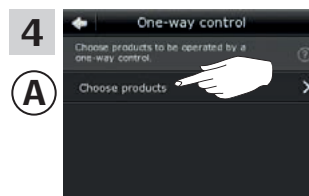

Tap "Choose products".

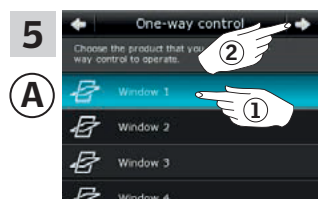

Scroll down the display and choose the product to be added (1).
Note: The individual products can be identified by tapping the icon. See also the section *Finding products*.
Tap ⇒ (2).

You now have 10 minutes to execute item 6 with (B).

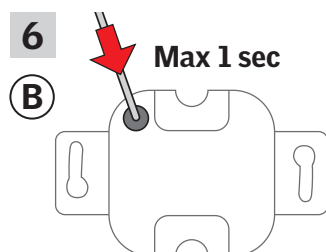

Press briefly the SET button on the back with a pointed object to register the new product.
You can now operate the chosen product with (B).



Tap ⏏ to finish.
Note: To add more products, tap "Choose more" and repeat items 5-7.

Setting up

Extension of your VELUX INTEGRA® system - Adding a control

3

Adding a VELUX INTEGRA® interface KLF 100 to your system already operated with a control pad KLR 200

The instructions below show how to copy the contents of control pad KLR 200 to interface KLF 100. See also the instructions for the interface.

Control pad KLR 200 to **send** a copy is called control (A).
Interface KLF 100 to **receive** a copy is called control (B).

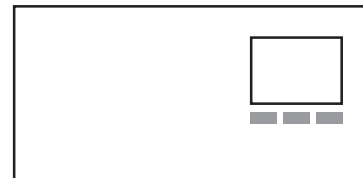

First execute item 1 with (B).



Follow the instructions for the interface until the section where menu item **H** is highlighted.

Now execute items 2-5 with (A).

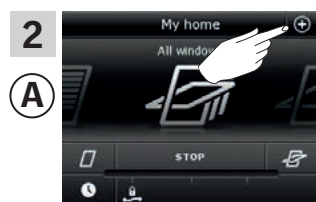

Tap ⊕.

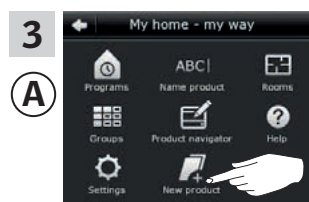

Tap "New product".

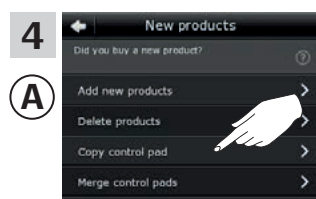

Tap "Copy control pad".

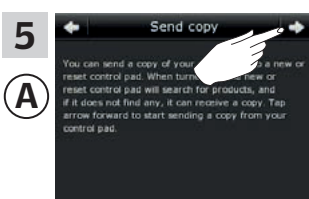

Tap ⇒.

Setting up

Extension of your VELUX INTEGRA® system - Adding a control

3

You now have two minutes to execute item 6 with **(B)**.

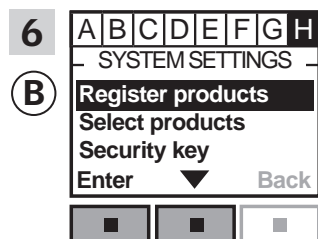

Press **[Left]** **[Down]** to highlight "Register products".
Press **[Enter]** to confirm your choice.

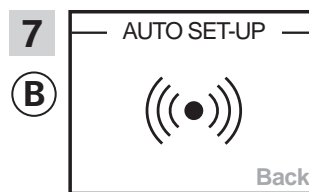

Automatic registration is running. Please wait. The registration can take up to one minute.

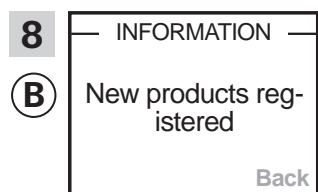

The display shows that the new product(s) has/have been registered.

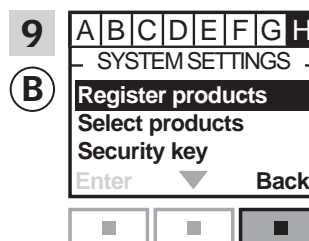

Press **[Back]** to finish.

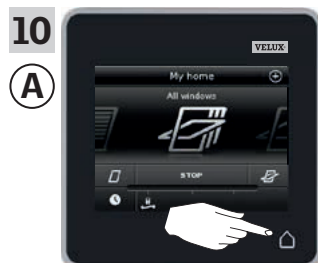

Tap **[Home]** to finish.

Setting up

Extension of your VELUX INTEGRA® system - Adding a control

3

Adding other types of io-homecontrol® controls to your system already operated with a VELUX INTEGRA® control pad KLR 200

The instructions below show how to copy the contents of control pad KLR 200 to another type of io-homecontrol® control. See also the instructions for the control in question.

Note: Only available for VELUX INTEGRA® products with radio frequency 868 MHz.

Control pad KLR 200 to **send** a copy is called control (A).
io-homecontrol® control to **receive** a copy is called control (B).

The instructions are divided into two sections:

Instructions for one-way controls  marked with this symbol on the product

Instructions for two-way controls  marked with this symbol on the product

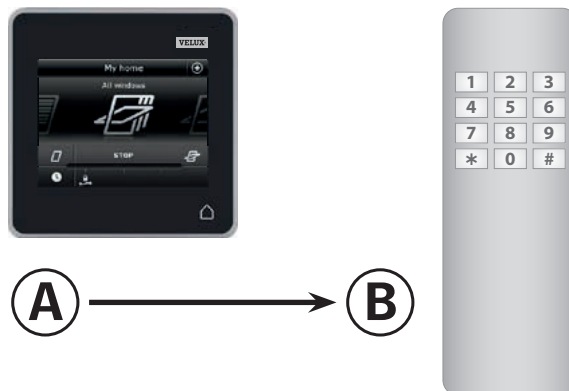

One-way controls 

First execute items 1-5 with (A).

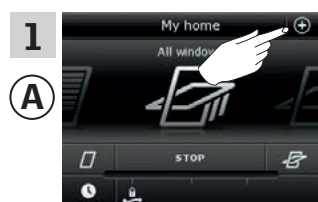

Tap ⊕

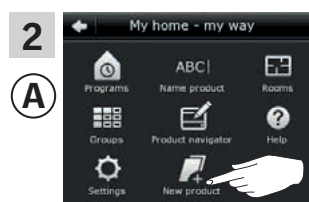

Tap "New product".

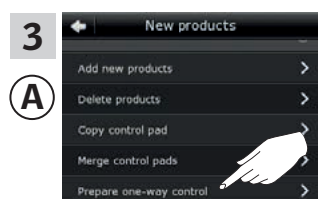

Tap "Prepare one-way control".

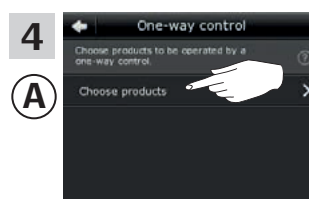

Tap "Choose products".

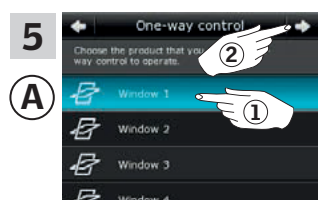

Scroll down the display and choose the product to be added (1).

Note: The individual products can be identified by tapping the icon. See also the section *Finding products*.

Tap ⇒ (2).

You now have 10 minutes to execute item 6 with (B).

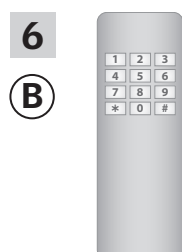

See instructions for the io-homecontrol® control.



Tap ⏠ to finish.

Setting up

Extension of your VELUX INTEGRA® system - Adding a control

3

Two-way controls

First execute items 1-4 with (A).

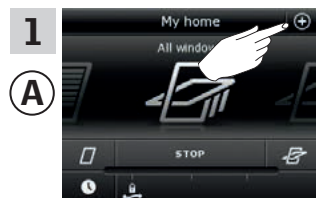

Tap ⊕.

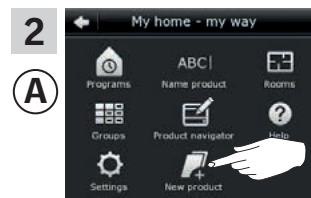

Tap "New product".

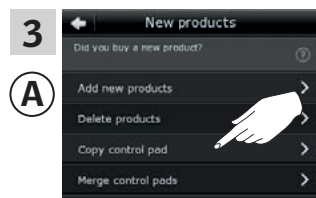

Tap "Copy control pad".

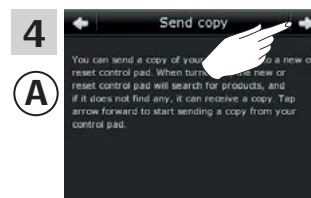

Tap ⇒.

You now have two minutes to execute item 5 with (B).

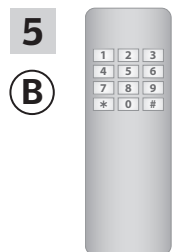

See instructions for the io-homecontrol® control. You may also refer to the section *Joint operation of io-homecontrol® products.*



Tap to finish.

Setting up

Extension of your VELUX INTEGRA® system - Adding a control

Adding a VELUX INTEGRA® control pad KLR 200 to your system already operated with another control

"Control" is used as a generic term for all devices that can operate VELUX INTEGRA® products.

To operate your VELUX INTEGRA® products with additional controls, the contents of the control already in use can be copied to your new control pad KLR 200.

Note: If you have edited the standard programs or made your own programs, these are not copied to your new control pad.

To find the control already operating your system, please see the page references below.



VELUX INTEGRA®
remote control KLR 100
(3LR A01)
Pages 55-56



VELUX INTEGRA®
interface KLF 050 fitted
into a wall switch/socket
of another make
(3LF D50)
Pages 63-64

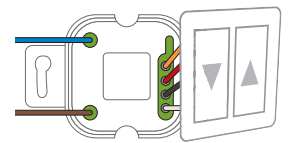

VELUX INTEGRA®
controller KRX 100
(3LF D02)
Pages 57-58

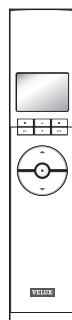

VELUX INTEGRA®
interface KLF 100
(3LF D01)
Pages 65-66

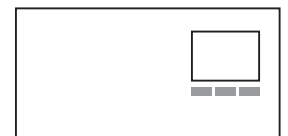

VELUX INTEGRA®
remote control without display
(3UR B01)
Pages 59-60



Other types of io-homecontrol®
control
Pages 67-68



VELUX INTEGRA®
control switch KLI 110
(3LI D01)
Pages 61-62



Setting up

Extension of your VELUX INTEGRA® system - Adding a control

3

Adding a VELUX INTEGRA® control pad KLR 200 to your system already operated with a remote control KLR 100

The instructions below show how to copy the contents from the remote control KLR 100 already in use to control pad KLR 200. See also the instructions for the remote control.

Remote control KLR 100 to **send** a copy is called control **A**. Control pad KLR 200 to **receive** a copy is called control **B**.

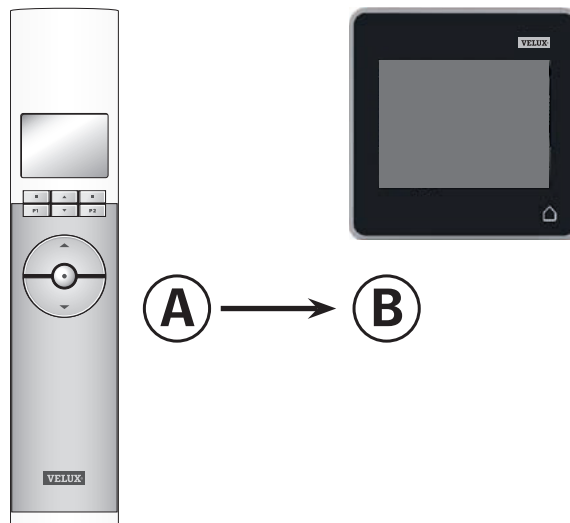

First execute items 1-4 with **B**.

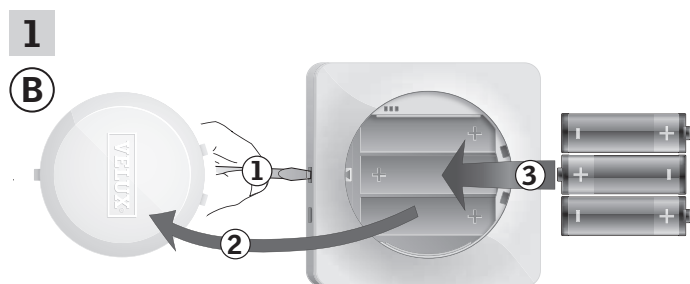

Remove the battery compartment lid by pressing the release button with a screwdriver as illustrated ①, ②. Insert batteries (type AA/LR6) ③. Replace lid.



In the display screen, roll the wheel in the directions of the arrows to choose language ①. Tap ⇨ ②.

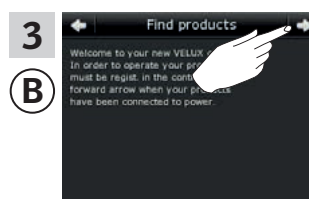

Follow the instructions in the display and tap ⇨ when you are ready.



Do **not** tap "Receive copy" until item 8.

Continue on the next page

Setting up

Extension of your VELUX INTEGRA® system - Adding a control

3

Now execute items 5-7 with (A).

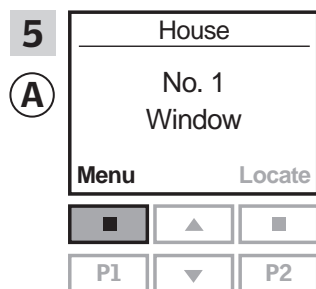

Press "Menu".

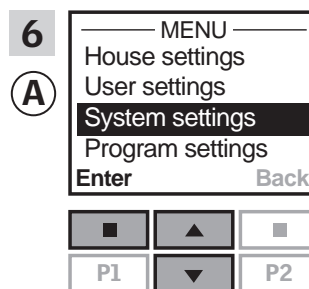

Press to highlight "System settings".
Press "Enter" to confirm your choice.

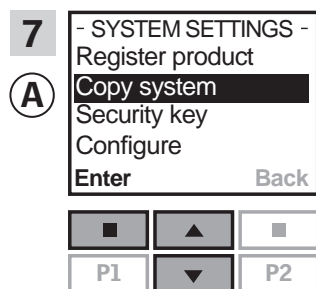

Press to highlight "Copy system".
Press "Enter" to confirm your choice.

You now have two minutes to execute item 8 with (B).

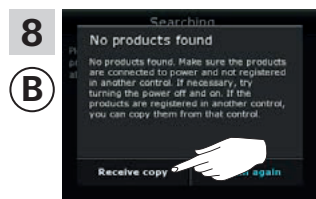

Tap "Receive copy".
Follow the instructions in the display and tap when you are ready.

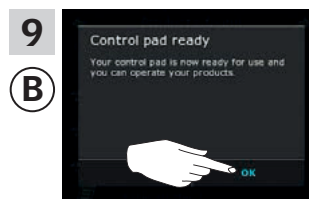

Tap "OK".



Tap to finish.

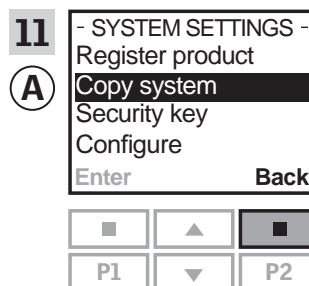

Press "Back" to finish.

Setting up

Extension of your VELUX INTEGRA® system - Adding a control

3

Adding a VELUX INTEGRA® control pad KLR 200 to your system already operated with a controller KRX 100

The instructions below show how to copy the contents from the controller KRX 100 already in use to control pad KLR 200. See also the instructions for the controller.

Note: Only available for VELUX INTEGRA® products with radio frequency 868 MHz.

Controller KRX 100 to **send** a copy is called control **A**.
Control pad KLR 200 to **receive** a copy is called control **B**.

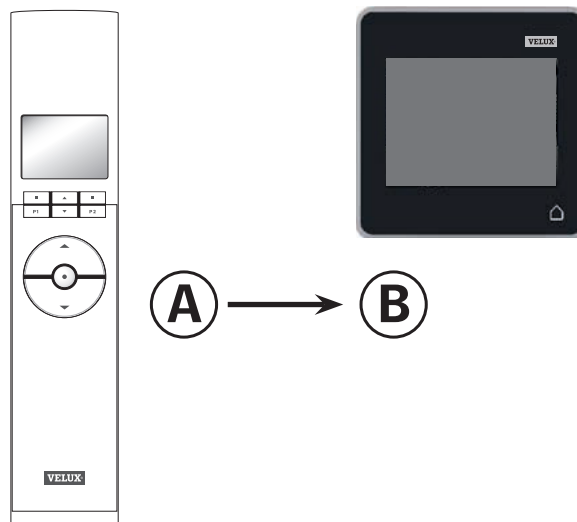

First execute items 1-4 with **B**.

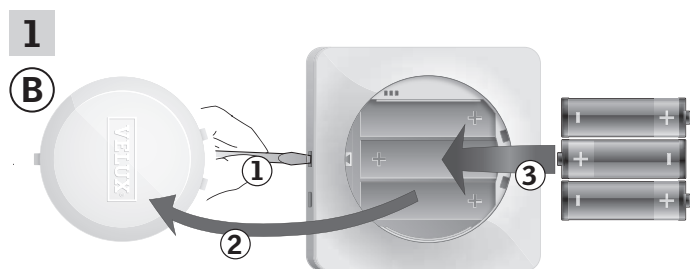

Remove the battery compartment lid by pressing the release button with a screwdriver as illustrated ①, ②.
Insert batteries (type AA/LR6) ③.
Replace lid.



In the display screen, roll the wheel in the directions of the arrows to choose language ①. Tap → ②.

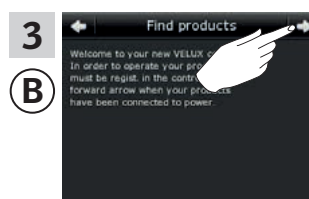

Follow the instructions in the display and tap → when you are ready.



Do not tap "Receive copy" until item 8.

Continue on the next page

Setting up

Extension of your VELUX INTEGRA® system - Adding a control

3

Now execute items 5-7 with (A).

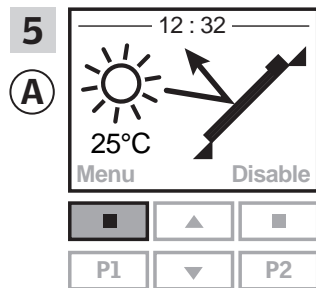

Press "Menu".

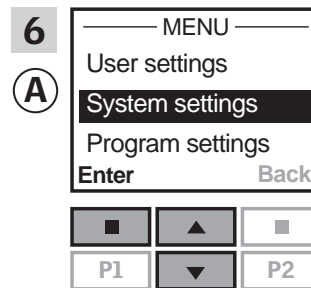

Press to highlight "System settings".
Press "Enter" to confirm your choice.

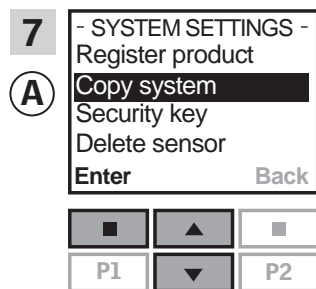

Press to highlight "Copy system".
Press "Enter" to confirm your choice.

You now have two minutes to execute item 8 with (B).



Tap "Receive copy".
Follow the instructions in the display and tap when you are ready.

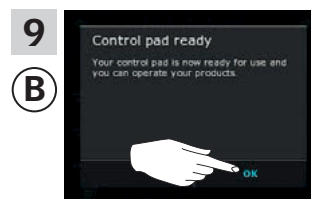

Tap "OK".

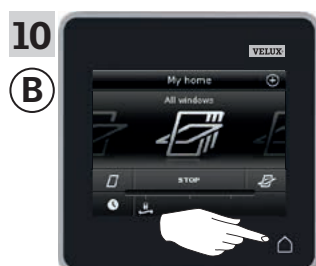

Tap to finish.

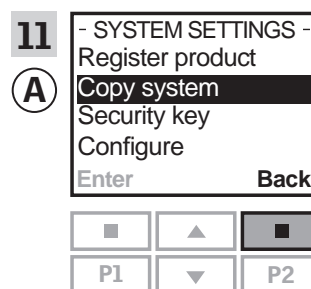

Press "Back" to finish.

Setting up

Extension of your VELUX INTEGRA® system - Adding a control

3

Adding a VELUX INTEGRA® control pad KLR 200 to your system already operated with a VELUX INTEGRA® remote control without display

The instructions below show how to copy the contents from the remote control without display already in use to control pad KLR 200. See also the instructions for the remote control.

Note: Only available for VELUX INTEGRA® products with radio frequency 868 MHz.

The remote control without display to **send** a copy is called control (A).

Control pad KLR 200 to **receive** a copy is called control (B).

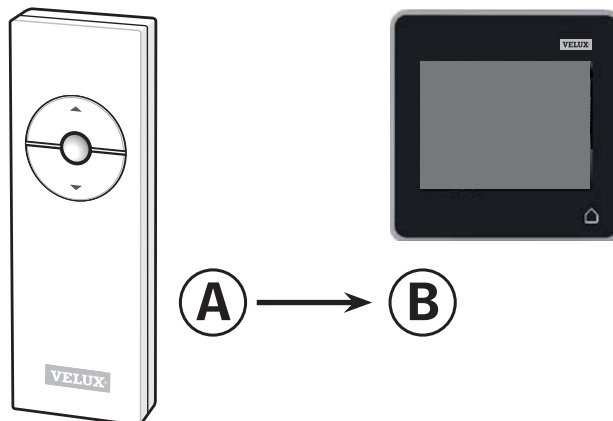

First execute item 1 with (A).

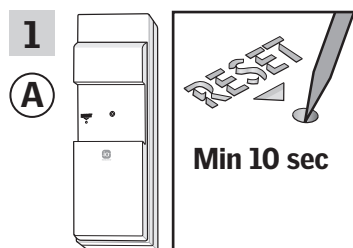

Press the RESET button on the back with a pointed object for at least 10 seconds to prepare the products for copying.

You now have two minutes to execute items 2-7 with (B).

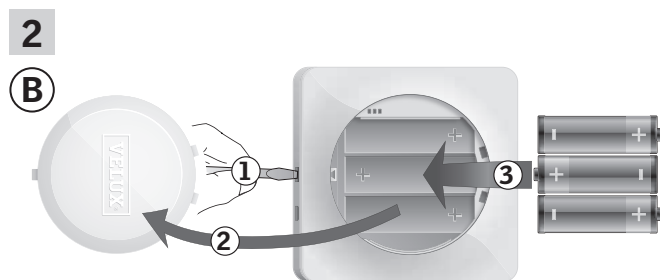

Remove the battery compartment lid by pressing the release button with a screwdriver as illustrated (1, 2). Insert batteries (type AA/LR6) (3). Replace lid.



In the display screen, roll the wheel in the directions of the arrows to choose language (1). Tap ⇒ (2).

Continue on the next page

Setting up

Extension of your VELUX INTEGRA® system - Adding a control

3

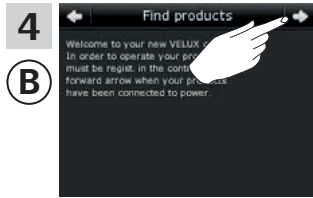

Follow the instructions in the display and tap ⇒ when you are ready.

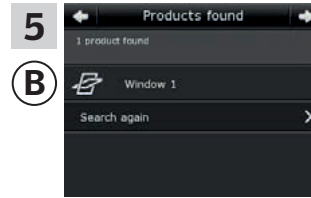

The control pad shows that it has found the products.
Note: Tap "Search again" if the control pad did not find all products and follow the instructions in the display. Go to the section *If the initial set-up fails* if the control pad still cannot find all products even if they are connected to power.

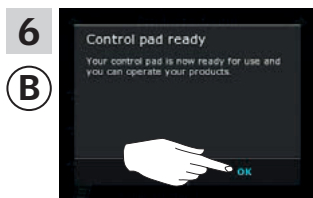

Tap "OK".



Tap  to finish.

Setting up

Extension of your VELUX INTEGRA® system - Adding a control

3

Adding a VELUX INTEGRA® control pad KLR 200 to your system already operated with a control switch KLI 110

The instructions below show how to copy the contents from the control switch KLI 110 already in use to control pad KLR 200. See also the instructions for the control switch.

Control switch KLI 110 to **send** a copy is called control ①.
Control pad KLR 200 to **receive** a copy is called control ②.

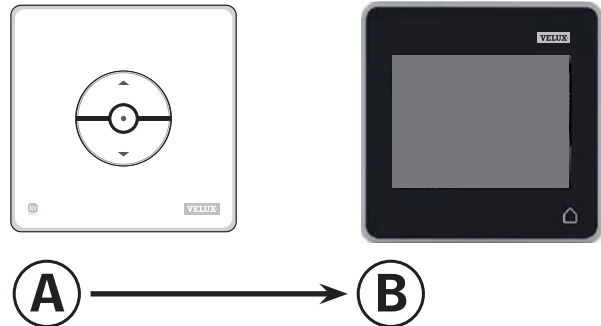

First execute item 1 with ①.

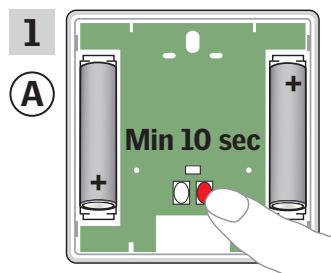

Press the RESET button on the back for at least 10 seconds to prepare the products for copying.

You now have two minutes to execute items 2-7 with ②.

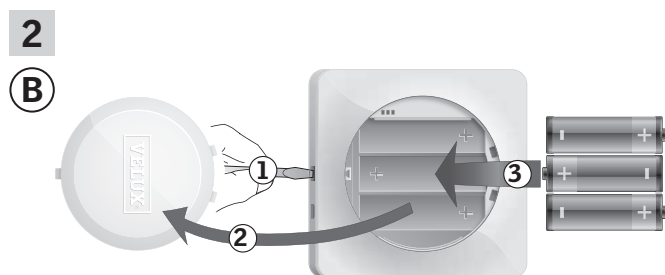

Remove the battery compartment lid by pressing the release button with a screwdriver as illustrated ①, ②. Insert batteries (type AA/LR6) ③. Replace lid.



In the display screen, roll the wheel in the directions of the arrows to choose language ①. Tap → ②.

Continue on the next page

Setting up

Extension of your VELUX INTEGRA® system - Adding a control

3

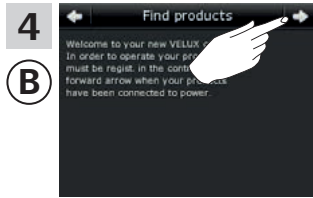

Follow the instructions in the display and tap ⇒ when you are ready.

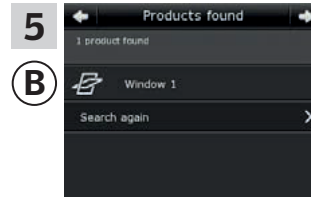

The control pad shows that it has found the products.
Note: Tap "Search again" if the control pad did not find all products and follow the instructions in the display. Go to the section *If the initial set-up fails* if the control pad still cannot find all products even if they are connected to power.

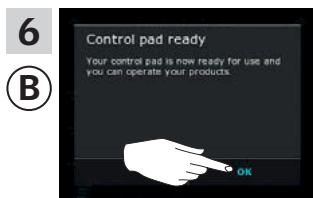

Tap "OK".

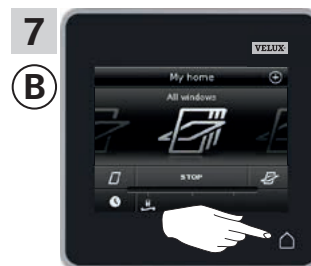

Tap ⏠ to finish.

Setting up

Extension of your VELUX INTEGRA® system - Adding a control

3

Adding a VELUX INTEGRA® control pad KLR 200 to your system already operated with an interface KLF 050 fitted into a wall switch/socket of another make

The instructions below show how to copy the contents from interface KLF 050 already in use to control pad KLR 200. See also the instructions for the interface.

Note: Only available for VELUX INTEGRA® products with radio frequency 868 MHz.

Interface KLF 050 to **send** a copy is called control (A).
Control pad KLR 200 to **receive** a copy is called control (B).

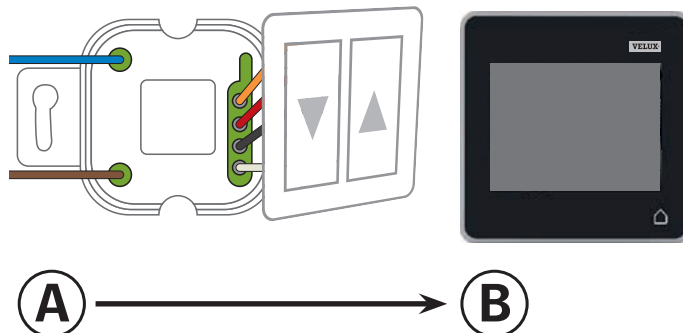

First execute item 1 with (A).

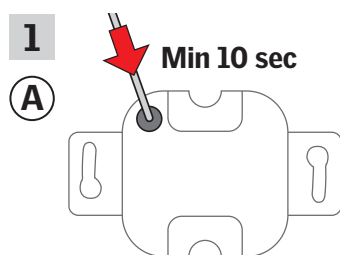

Press the SET button on the back with a pointed object for at least 10 seconds to prepare the products for copying.

You now have two minutes to execute items 2-7 with (B).

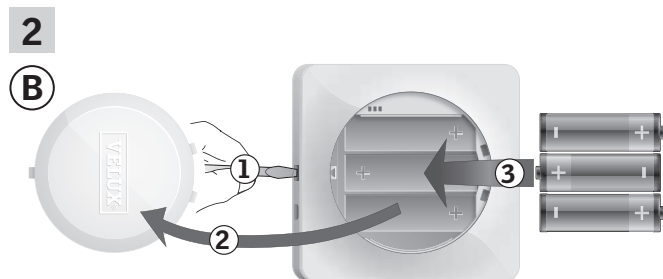

Remove the battery compartment lid by pressing the release button with a screwdriver as illustrated (1), (2).
Insert batteries (type AA/LR6) (3).
Replace lid.



In the display screen, roll the wheel in the directions of the arrows to choose language (1).
Tap → (2).

Continue on the next page

Setting up

Extension of your VELUX INTEGRA® system - Adding a control

3

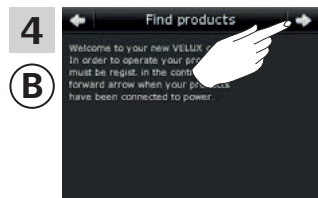

4
B Follow the instructions in the display and tap ⇒ when you are ready.

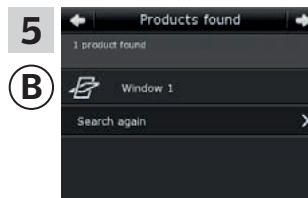

5
B The control pad shows that it has found the products.
Note: Tap "Search again" if the control pad did not find all products and follow the instructions in the display. Go to the section *If the initial set-up fails* if the control pad still cannot find all products even if they are connected to power.

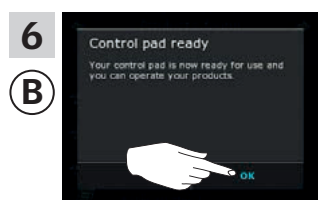

6
B Tap "OK".

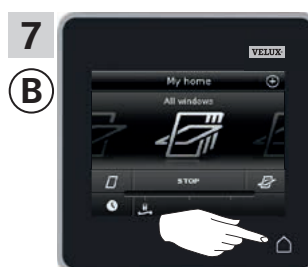

7
B Tap ⏠ to finish.

Setting up

Extension of your VELUX INTEGRA® system - Adding a control

3

Adding a VELUX INTEGRA® control pad KLR 200 to your system already operated with an interface KLF 100

The instructions below show how to copy the contents from interface KLF 100 already in use to control pad KLR 200. See also the instructions for the interface.

Interface KLF 100 to **send** a copy is called control **A**.
Control pad KLR 200 to **receive** a copy is called control **B**.

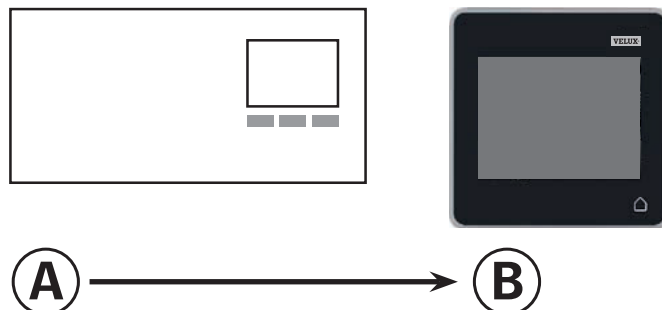

First execute item 1-4 with **B**.

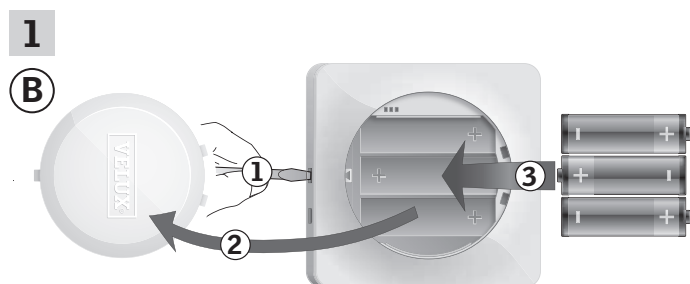

Remove the battery compartment lid by pressing the release button with a screwdriver as illustrated **1**, **2**.
Insert batteries (type AA/LR6) **3**.
Replace lid.



In the display screen, roll the wheel in the directions of the arrows to choose language **1**.
Tap **⇒** **2**.

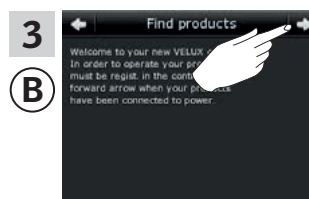

Follow the instructions in the display and tap **⇒** when you are ready.



Do **not** tap "Receive copy" until item 6.

Continue on the next page

Setting up

Extension of your VELUX INTEGRA® system - Adding a control

3

Now execute item 5 with (A).

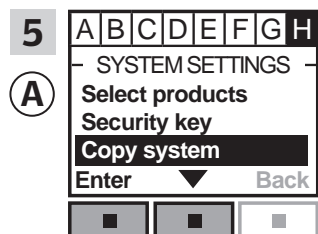

Follow the instructions for the interface until the section where menu item **H** is highlighted.
Press **Enter** to highlight "Copy system".
Press **Enter** to confirm your choice.

You now have two minutes to execute item 6 with (B).

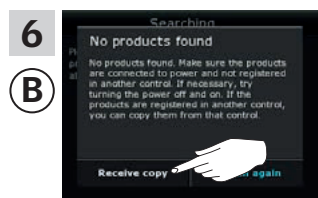

Tap "Receive copy".
Follow the instructions in the display and tap **⇒** when you are ready.

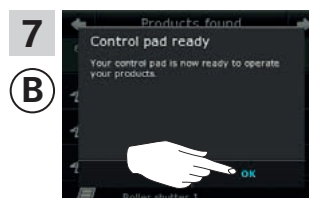

Tap "OK".

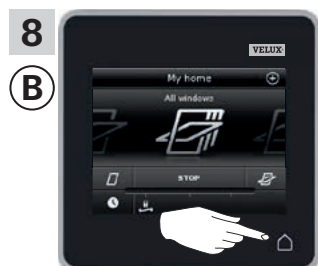

Tap **⏠** to finish.

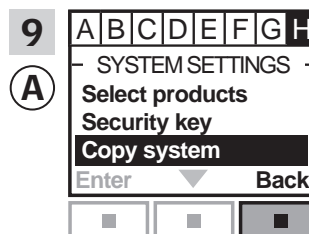

Press **Back** to finish.

Setting up

Extension of your VELUX INTEGRA® system - Adding a control

Adding a VELUX INTEGRA® control pad KLR 200 to your system already operated with another type of io-homecontrol® control

The instructions below show how to copy the contents from the io-homecontrol® control already in use to control pad KLR 200. See also the instructions for the control or the section *Joint operation of io-homecontrol® products*.

Note: Only available for VELUX INTEGRA® products with radio frequency 868 MHz.

io-homecontrol® control to **send** a copy is called control (A).
Control pad KLR 200 to **receive** a copy is called control (B).

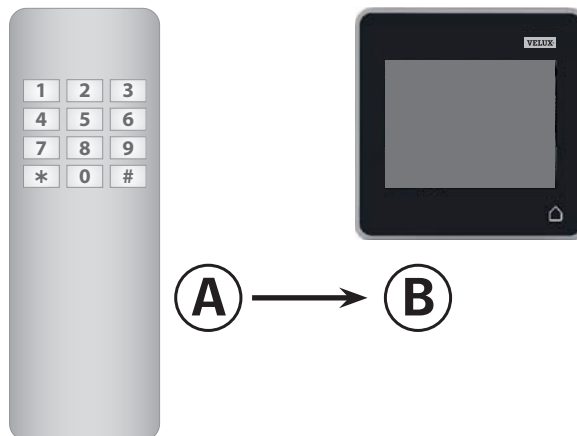

First execute items 1-4 with (A).

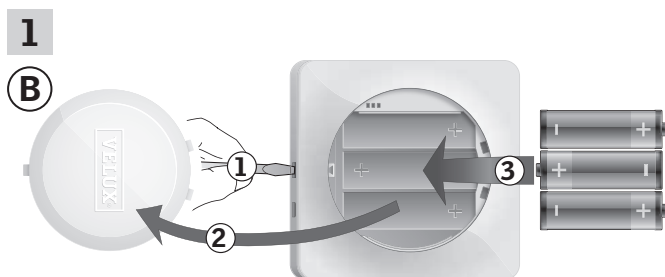

Remove the battery compartment lid by pressing the release button with a screwdriver as illustrated (1), (2).
Insert batteries (type AA/LR6) (3).
Replace lid.



In the display screen, roll the wheel in the directions of the arrows to choose language (1).
Tap ⇨ (2).

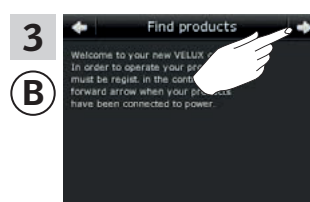

Follow the instructions in the display and tap ⇨ when you are ready.



Do **not** tap "Receive copy" until item 6.

Setting up

Extension of your VELUX INTEGRA® system - Adding a control

3

Now execute item 5 with (A).

5
(A)



See instructions for the io-homecontrol® control.
If you have two-way controls, you may also refer to the section *Joint operation of io-homecontrol® products*.

You now have two minutes to execute item 6 with (B).

6
(B)



Tap "Receive copy".
Follow the instructions in the display and tap ⇒ when you are ready.

7
(B)

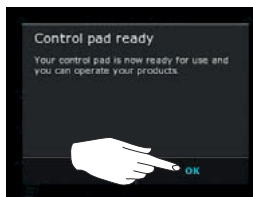

Tap "OK".

8
(B)



Tap ⏏ to finish.

Allowing controls already in use in their separate systems to operate each other's products

"Control" is used as a generic term for all devices that can operate VELUX INTEGRA® products.

If you have two (or more) controls that are already in use in their separate systems where they operate their separate products, you can make these operate each other's products. To do this, you must register all products already registered in each separate control in both controls so that all products will have the same security key.

To find the control with which control pad KLR 200 is to be merged, please see the page references below.



VELUX INTEGRA®
control pad KLR 200
(3LR A02)
Pages 70-71



VELUX INTEGRA®
control switch KLI 110
(3LI D01)
Page 77



VELUX INTEGRA®
remote control KLR 100
(3LR A01)
Pages 72-73



VELUX INTEGRA®
interface KLF 050 fitted
into a wall switch/socket
of another make
(3LF D50)
Page 78

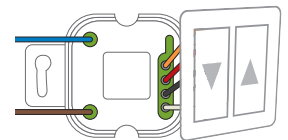

VELUX INTEGRA®
controller KRX 100
(3LF D02)
Pages 74-75

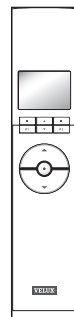

VELUX INTEGRA®
interface KLF 100
(3LF D01)
Pages 79-80



VELUX INTEGRA®
remote control without display
(3UR B01)
Page 76

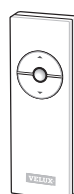

Other types of io-homecontrol®
controls
Pages 81-83



Setting up

Extension of your VELUX INTEGRA® system - Adding a control

3

Allowing two or more VELUX INTEGRA® control pads KLR 200 in their separate systems to operate each other's products

The instructions below show how to make a control pad KLR 200 also operate the products registered in another control pad KLR 200.

Control pad KLR 200 to **receive** products is called control ①.
Control pad KLR 200 to **send** products is called control ②.

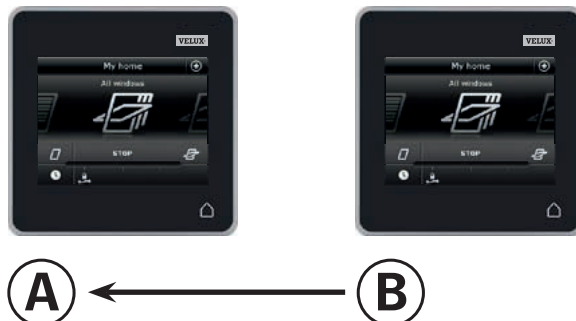

First execute items 1-4 with ①.

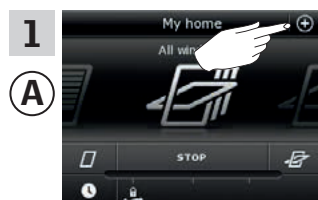

Tap ⊕.

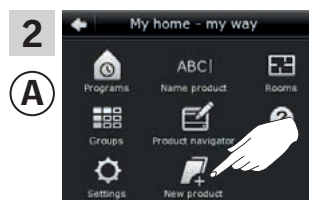

Tap "New product".

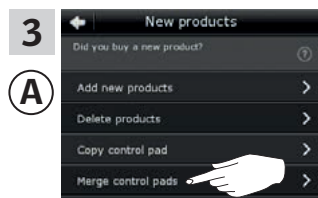

Tap "Merge control pads".

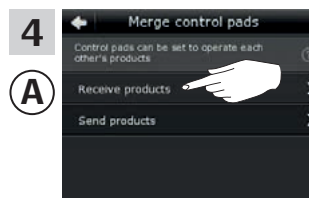

Tap "Receive products".

You now have two minutes to execute items 5-8 with ②.

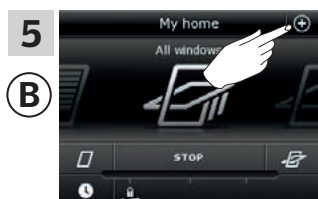

Tap ⊕.

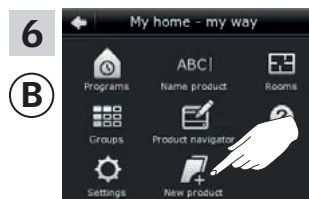

Tap "New product".

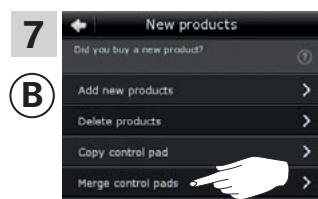

Tap "Merge control pads".

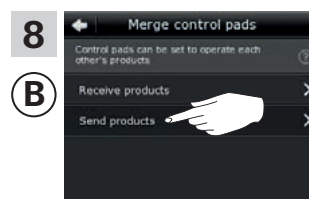

Tap "Send products".
② now transfers products to ①.

Continue on the next page

Setting up

Extension of your VELUX INTEGRA® system - Adding a control

3

Execute items 9-11 with ①.

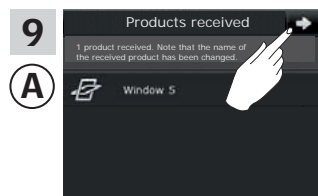

Tap →.

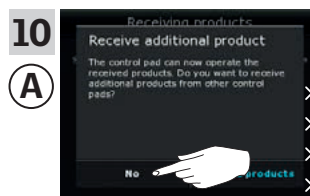

The display asks if you want to receive more products.
Tap "No".



Tap ⏏ to finish.

Execute items 12-13 with ②.



Tap "No" if the control pad shall be able to operate its own products only.
Note: Tap "Yes" if the opposite is the case.



Tap ⏏ to finish.

Now ① can operate all products. To be able to operate all products with ② as well, you must follow the section *Adding products to the control pad*.

If you have additional controls that prior to the transfer were able to operate the same products as ①, their security keys must also be synchronised to be able to operate these products again. Please refer to the list on page 84.

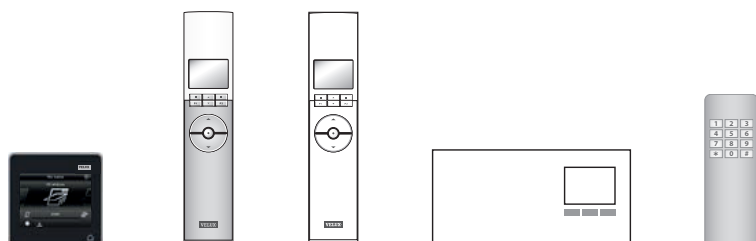

Setting up

Extension of your VELUX INTEGRA® system - Adding a control

3

Allowing a VELUX INTEGRA® control pad KLR 200 and a remote control KLR 100 in their separate systems to operate each other's products

The instructions below show how to make a control pad KLR 200 also operate the products registered in a remote control KLR 100.

Control pad KLR 200 to **receive** products is called control (A).
Remote control KLR 100 to **send** products is called control (B).

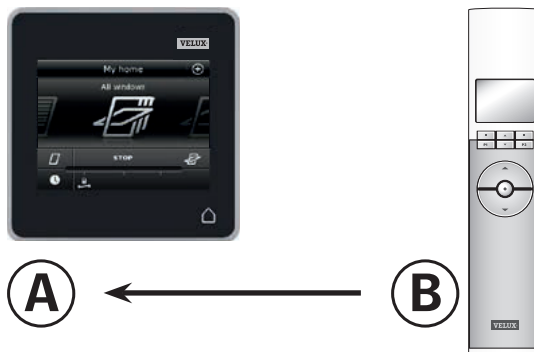

First execute items 1-4 with (A).

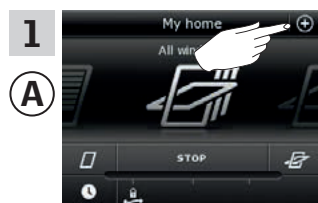

Tap ⊕.

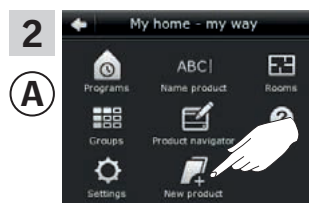

Tap "New product".

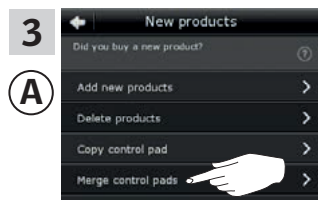

Tap "Merge control pads".

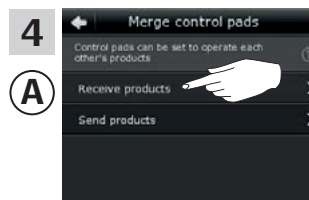

Tap "Receive products".

You now have two minutes to execute items 5-7 with (B).

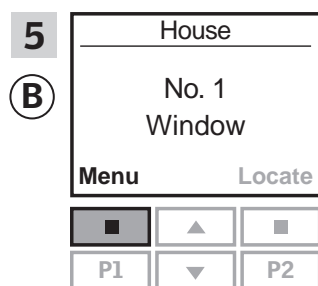

Press [Menu] "Menu".

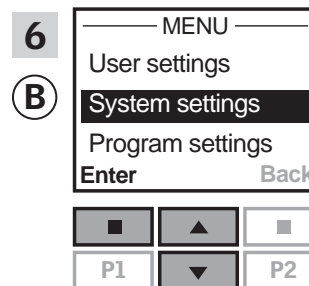

Press [Up] to highlight "System settings".
Press [Enter] to confirm your choice.

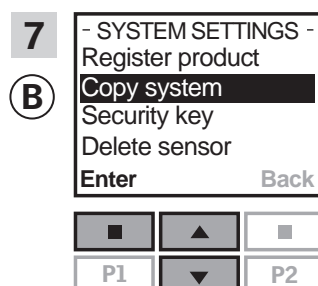

Press [Up] to highlight "Copy system".
Press [Enter] to confirm your choice.
(B) now transfers products to (A).

Continue on the next page

Setting up

Extension of your VELUX INTEGRA® system - Adding a control

3

Execute items 8-10 with Ⓐ.

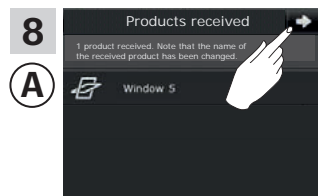

Tap ⇒.

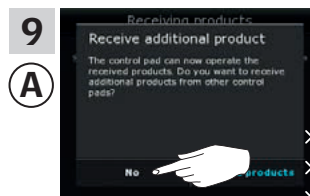

The display asks if you want to receive more products. Tap "No".



Tap ⏠ to finish.

Execute item 11 with Ⓑ.

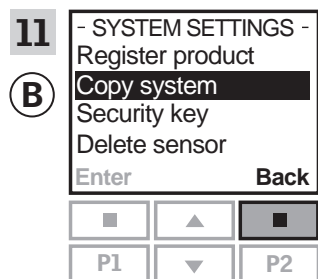

Press ⏪ "Back" to finish.

Now Ⓐ can operate all products. To be able to operate all products with Ⓑ as well, you must follow the section *Registering new products* in the directions for use for remote control KLR 100.

If you have additional controls that prior to the transfer were able to operate the same products as Ⓐ, their security keys must also be synchronised to be able to operate these products again. Please refer to the list on page 84.

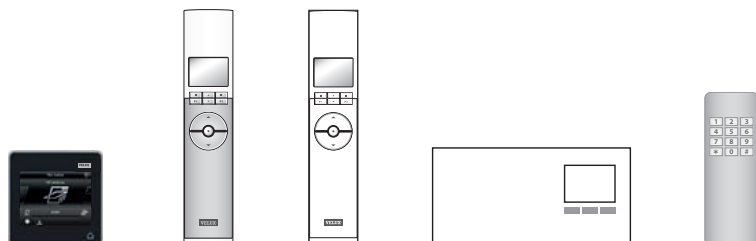

Setting up

Extension of your VELUX INTEGRA® system - Adding a control

3

Allowing a VELUX INTEGRA® control pad KLR 200 and a controller KRX 100 in their separate systems to operate each other's products

The instructions below show how to make a control pad KLR 200 also operate the products registered in a controller KRX 100.

Note: Only available for VELUX INTEGRA® products with radio frequency 868 MHz.

Control pad KLR 200 to **receive** products is called control (A).
Controller KRX 100 to **send** products is called control (B).

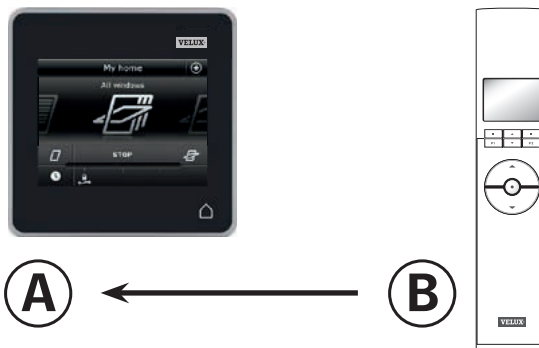

First execute items 1-4 with (A).

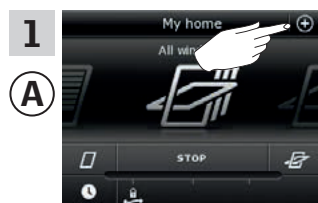

Tap +.

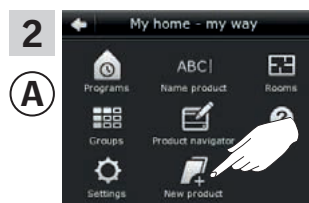

Tap "New product".

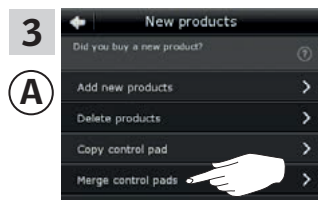

Tap "Merge control pads".

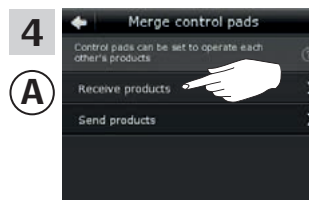

Tap "Receive products".

You now have two minutes to execute items 5-7 with (B).

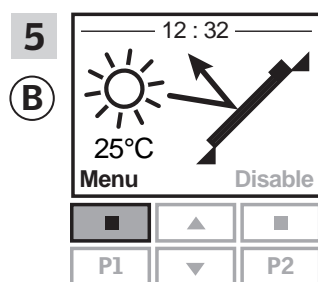

Press [Menu] "Menu".

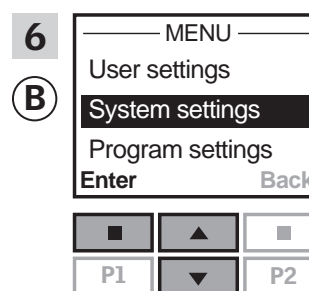

Press [Up] to highlight "System settings".
Press [Enter] to confirm your choice.

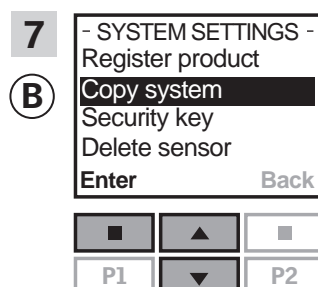

Press [Up] to highlight "Copy system".
Press [Enter] to confirm your choice.
(B) now transfers products to (A).

Continue on the next page

Setting up

Extension of your VELUX INTEGRA® system - Adding a control

3

Execute items 8-10 with Ⓐ.

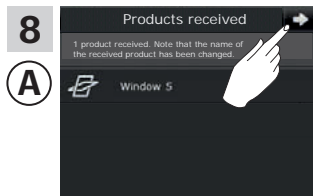

Tap ⇒.

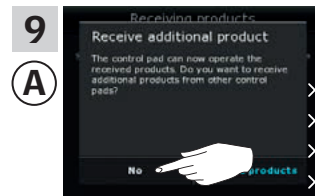

The display asks if you want to receive more products.
Tap "No".



Tap ⏠ to finish.

Execute item 11 with Ⓑ.

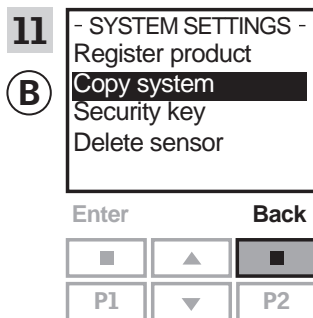

Press ⏪ "Back" to finish.

Now Ⓐ can operate all products. To be able to operate all products with Ⓑ as well, you must follow the section *Registering sunshcreening products in controller* in the instructions for controller KRX 100.

If you have additional controls that prior to the transfer were able to operate the same products as Ⓐ, their security keys must also be synchronised to be able to operate these products again. Please refer to the list on page 84.

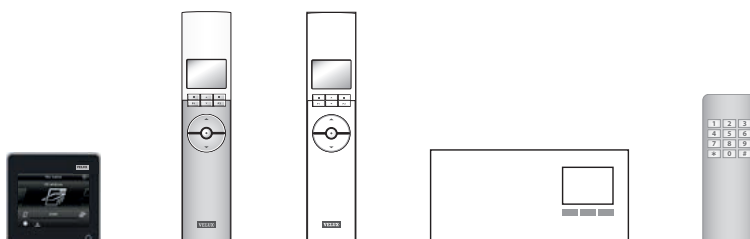

Setting up

Extension of your VELUX INTEGRA® system - Adding a control

3

Allowing a VELUX INTEGRA® control pad KLR 200 and a VELUX INTEGRA® remote control without display in their separate systems to operate each other's products

The instructions below show how to make a control pad KLR 200 also operate the products registered in a remote control without display.

Note: Only available for VELUX INTEGRA® products with radio frequency 868 MHz.

Control pad KLR 200 to **receive** products is called control **(A)**.
The remote control without display to **send** products is called control **(B)**.

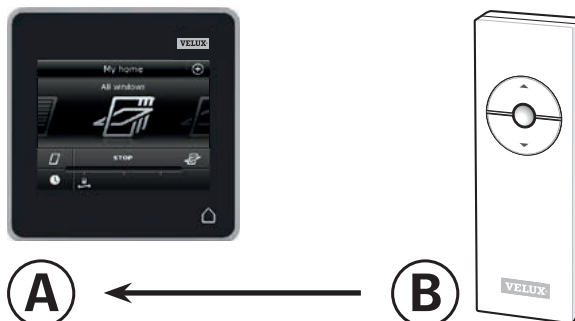

First execute item 1 with **(B)**.

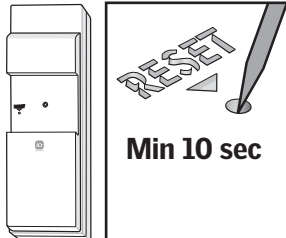
1 **(B)**  Press the RESET button on the back with a pointed object for at least 10 seconds to prepare the products for registration.

You now have 10 minutes to execute items 2-6 with **(A)**.

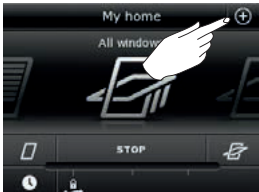
2 **(A)**  Tap ⊕.

3 **(A)**  Tap "New product".

4 **(A)**  Tap "Add new products".

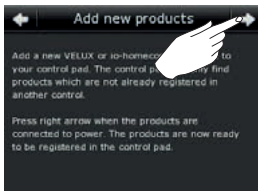
5 **(A)**  Tap ⇒.

6 **(A)**  Tap ⇒ when the control pad has found the products ①. You can now operate the new products. Tap ⏏ to finish ②.

To be able to operate selected products with **(B)** as well, you must follow the section *Additional remote controls* in the instructions for control system KUX 100.

Setting up

Extension of your VELUX INTEGRA® system - Adding a control

3

Allowing a VELUX INTEGRA® control pad KLR 200 and a control switch KLI 110 in their separate systems to operate each other's products

The instructions below show how to make a control pad KLR 200 also operate the products registered in a control switch KLI 110.

Control pad KLR 200 to **receive** products is called control (A).
Control switch KLI 110 to **send** products is called control (B).

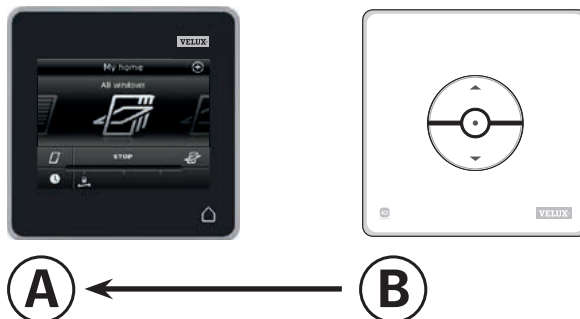

First execute item 1 with (B).

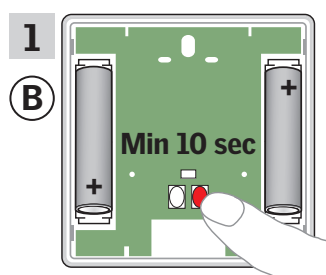

Press the RESET button on the back for at least 10 seconds to prepare the products for registration.

You now have 10 minutes to execute items 2-6 with (A).

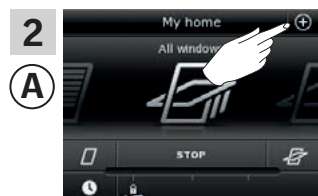

Tap ⊕.

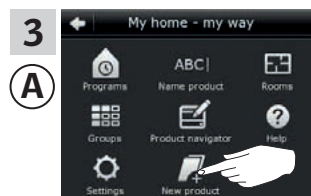

Tap "New product".



Tap "Add new products".

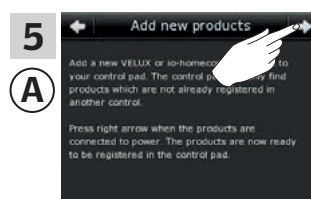

Tap ⇒.



Tap ⇒ when the control pad has found the products (1).
You can now operate the new products.
Tap ⏠ to finish (2).

To be able to operate selected products with (B) as well, you must follow the section *More than one activation control* in the instructions for control switch KLI 110.

Setting up

Extension of your VELUX INTEGRA® system - Adding a control

3

Allowing a VELUX INTEGRA® control pad KLR 200 and an interface KLF 050 in their separate systems to operate each other's products

The instructions below show how to make a control pad KLR 200 also operate the products registered in an interface KLF 050.

Note: Only available for VELUX INTEGRA® products with radio frequency 868 MHz.

Control pad KLR 200 to **receive** products is called control (A).
Interface KLF 050 to **send** products is called control (B).

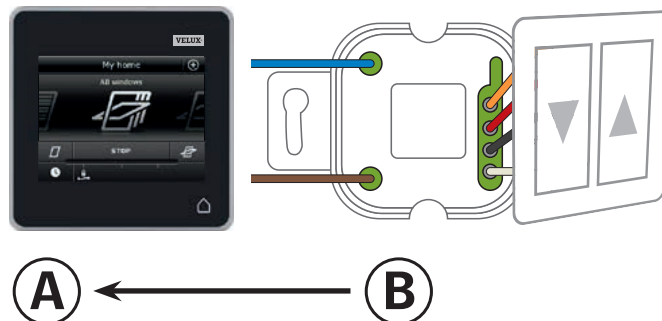

First execute item 1 with (B).

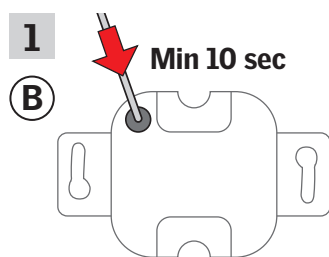

Press the SET button on the back with a pointed object for at least 10 seconds to prepare the products for registration.

You now have 10 minutes to execute items 2-6 with (A).

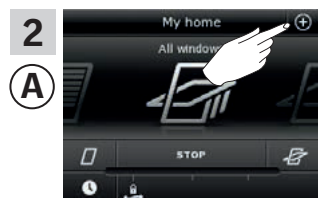

Tap +.

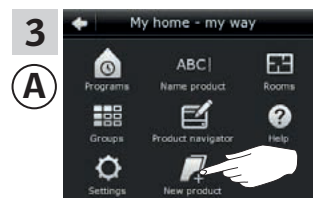

Tap "New product".



Tap "Add new products".



Tap =>.



Tap => when the control pad has found the products (1).
You can now operate the new products.
Tap ⏠ to finish (2).

To be able to operate selected products with (B) as well, you must follow the section *Putting into operation* in the instructions for interface KLF 050.

Setting up

Extension of your VELUX INTEGRA® system - Adding a control

3

Allowing a VELUX INTEGRA® control pad KLR 200 and an interface KLF 100 in their separate systems to operate each other's products

The instructions below show how to make a control pad KLR 200 also operate the products registered in an interface KLF 100.

Control pad KLR 200 to **receive** products is called control ①.
Interface KLF 100 to **send** products is called control ②.

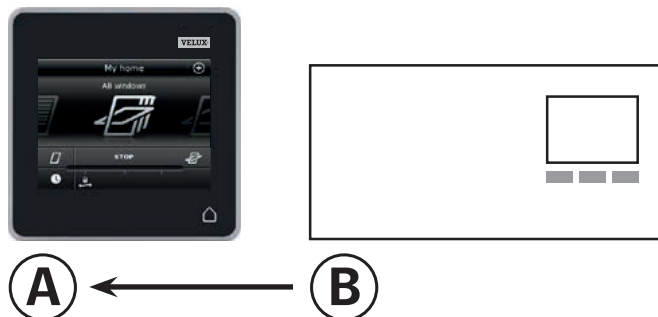

First execute items 1-4 with ①.

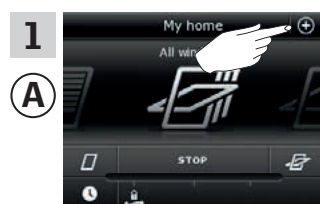

Tap ⊕.

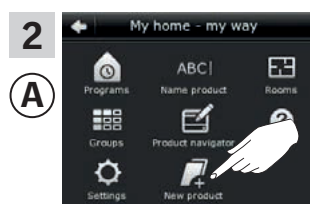

Tap "New product".

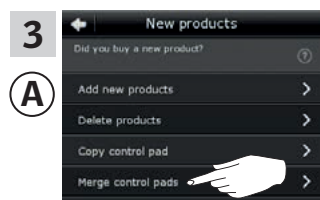

Tap "Merge control pads".

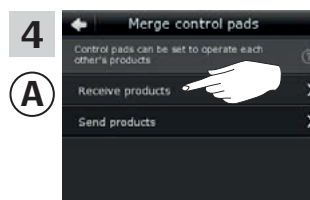

Tap "Receive products".

You now have two minutes to execute item 5 with ②.

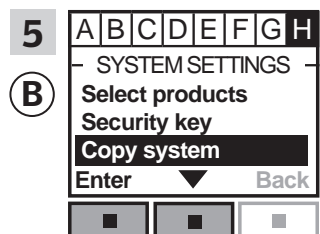

Follow the instructions for the interface until the section where menu item **H** is highlighted.
Press **⏏** ▼ to highlight "Copy system".
Press **⏏** "Enter" to confirm your choice.
② now transfers products to ①.

Continue on the next page

Setting up

Extension of your VELUX INTEGRA® system - Adding a control

3

Execute items 6-8 with (A).

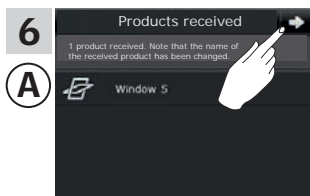

Tap ⇒.

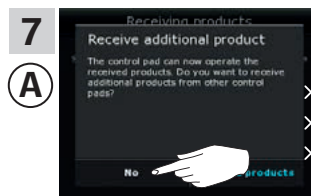

The display asks if you want to receive more products.
Tap "No".



Tap ⏠ to finish.

Execute item 9 with (B).

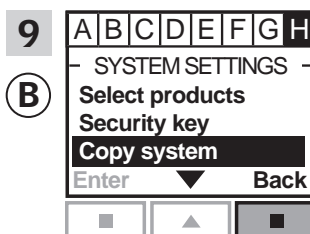

Press ◀ "Back" to finish.

Now (A) can operate all products. To be able to operate all products with (B) as well, you must follow the section *Register products* in the directions for use for interface KLF 100.

If you have additional controls that prior to the transfer were able to operate the same products as (A), their security keys must also be synchronised to be able to operate these products again. Please refer to the list on page 84.

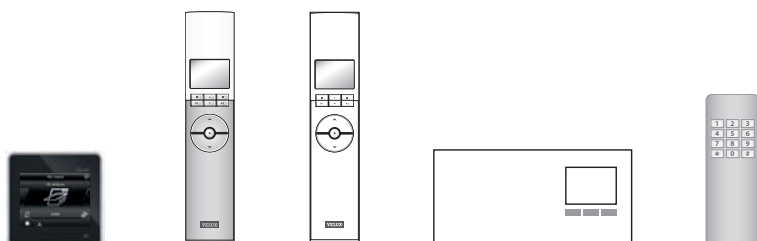

Setting up

Extension of your VELUX INTEGRA® system - Adding a control

3

Allowing a VELUX INTEGRA® control pad KLR 200 and another type of io-homecontrol® control in their separate systems operate each other's products

The instructions below show how to make a control pad KLR 200 also operate the products registered in another type of io-homecontrol® control.

Note: Only available for VELUX INTEGRA® products with radio frequency 868 MHz.

Control pad KLR 200 to **receive** products is called control (A).
io-homecontrol® control to **send** products is called control (B).

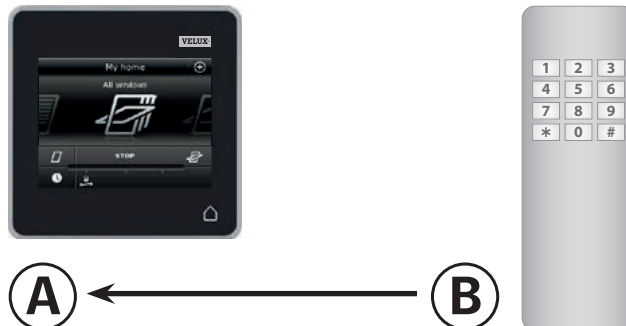

The instructions are divided into two sections:

Instructions for one-way controls  marked with this symbol on the product

Instructions for two-way controls  marked with this symbol on the product

One-way controls 

First execute item 1 with (B).

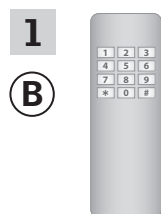

See instructions for the io-homecontrol® control.

You now have 10 minutes to execute items 2-6 with (A).

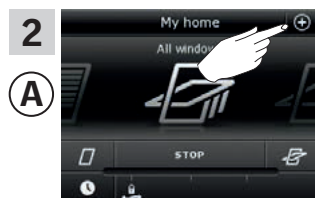

Tap ⊕.

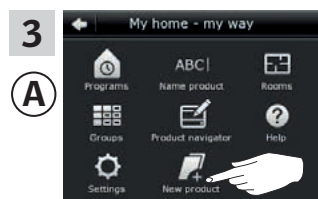

Tap "New product".



Tap "Add new products".



Tap ⇒.



Tap ⇒ when the control pad has found the products ①. You can now operate the new products. Tap ⏠ to finish ②.

To be able to operate selected products with (B) as well, you must follow items 1-7 in the section *Adding other types of io-homecontrol® controls to your system already operated with a VELUX INTEGRA® control pad KLR 200.*

Setting up

Extension of your VELUX INTEGRA® system - Adding a control

3

Two-way controls 

First execute items 1-4 with (A).

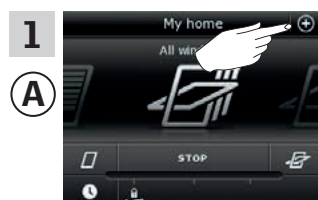

Tap ⊕.

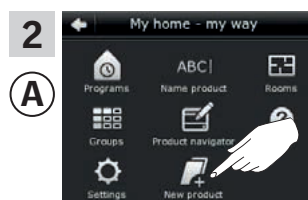

Tap "New product".

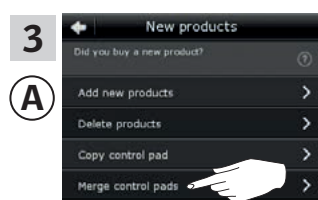

Tap "Merge control pads".

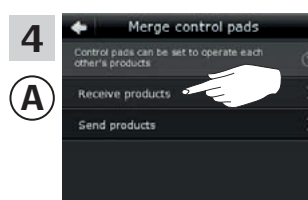

Tap "Receive products".

You now have two minutes to execute item 5 with (B).

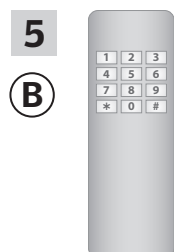

See instructions for the io-homecontrol® control. You may also refer to the section *Joint operation of io-homecontrol® products*. (B) now transfers products to (A).

Continue on the next page 

Setting up

Extension of your VELUX INTEGRA® system - Adding a control

3

Execute items 6-8 with (A).

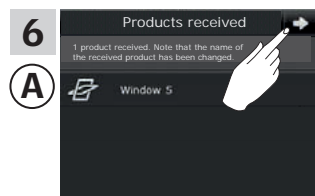

Tap ⇨.

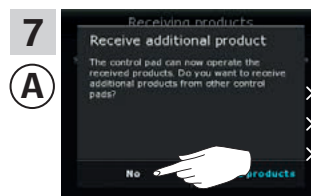

The display asks if you want to receive more products.

Tap "No".



Tap to finish.

Now (A) can operate all products. To be able to operate all products with (B) as well, you must follow the instructions for the io-homecontrol® control.

If you have additional controls that prior to the transfer were able to operate the same products as (A), their security keys must also be synchronised to be able to operate these products again. Please refer to the list on page 84.

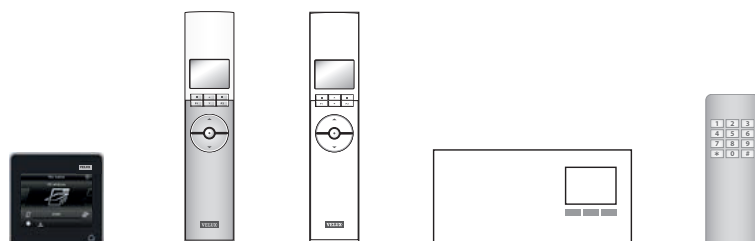

Setting up

Extension of your VELUX INTEGRA® system - Adding a control

Synchronise the security keys in controls in the same system so they can operate products again

"Control" is used as a generic term for all devices that can operate VELUX INTEGRA® products.

If you have a control that no longer can operate the products because they have been given a new security key, the security key of this control must be synchronised to be able to operate the products again.

To find the control that is to have the same security key as control pad KLR 200, please see the page references below.



VELUX INTEGRA®
control pad KLR 200
(3LR A02)
Pages 85-86



VELUX INTEGRA®
interface KLF 100
(3LF D01)
Pages 91-92

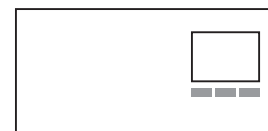

VELUX INTEGRA®
remote control KLR 100
(3LR A01)
Pages 87-88



Other types of io-homecontrol®
controls
Page 93



VELUX INTEGRA®
controller KRX 100
(3LF D02)
Pages 89-90

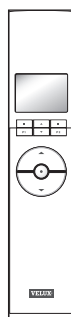

Setting up

Extension of your VELUX INTEGRA® system - Adding a control

3

Synchronise the security keys in two VELUX INTEGRA® control pads KLR 200 in the same system so they both can operate products again

The instructions below show how to transfer the security key of a control pad KLR 200 to another control pad KLR 200.

Control pad KLR 200 to **send** the security key is called control ①.
Control pad KLR 200 to **receive** the security key is called control ②.

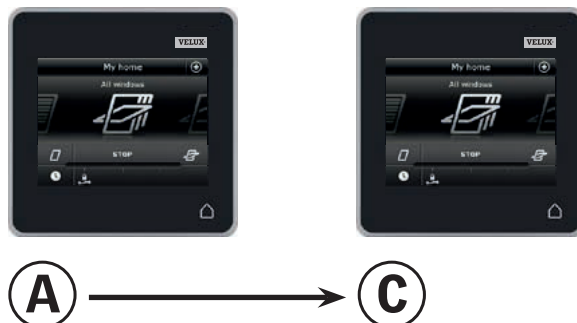

First execute items 1-4 with ①.

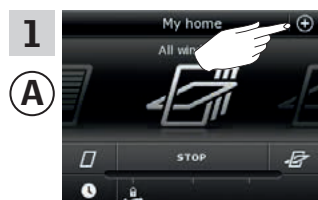

Tap ⊕.

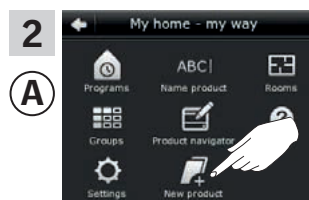

Tap "New product".

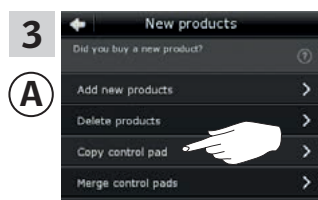

Tap "Copy control pad".

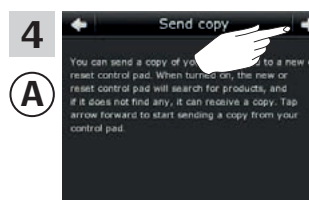

Tap ⇒.

You now have two minutes to execute items 5-8 with ②.

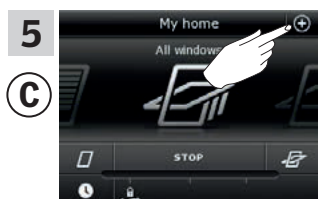

Tap ⊕.

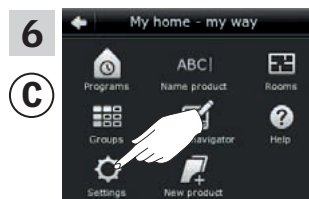

Tap "Settings".

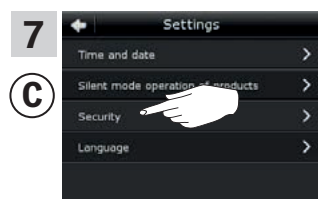

Tap "Security".

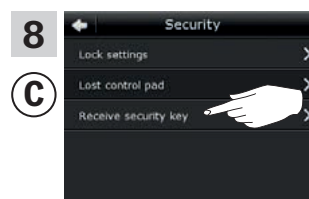

Tap "Receive security key".

Continue on the next page

Setting up

Extension of your VELUX INTEGRA® system - Adding a control

3

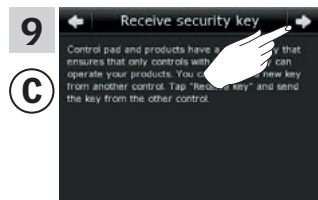

Tap ⇒.

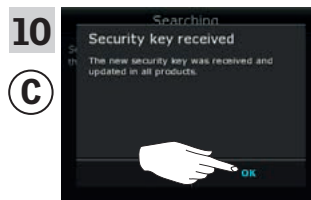

Tap "OK".



Tap  to finish.

The security key is now identical in both controls, and © can operate products again.

If you have additional controls in the same system, you must also synchronise their security keys to make them operate the products again. Please refer to the list on page 84.

To be able to operate all products with © as well, you must follow the section *Adding products to the control pad*.

Setting up

Extension of your VELUX INTEGRA® system - Adding a control

3

Synchronise the security keys in a VELUX INTEGRA® control pad KLR 200 and a remote control KLR 100 in the same system so they both can operate products again

The instructions below show how to transfer the security key of a control pad KLR 200 to a remote control KLR 100.

Control pad KLR 200 to **send** the security key is called control ①. Remote control KLR 100 to **receive** the security key is called control ②.

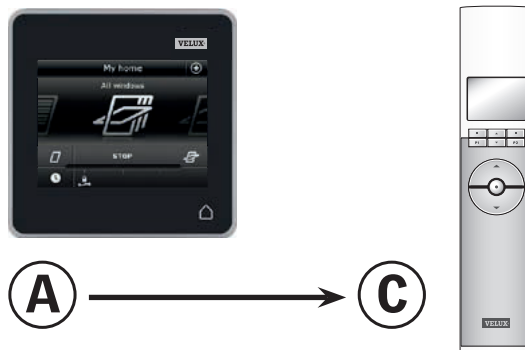

First execute items 1-4 with ①.

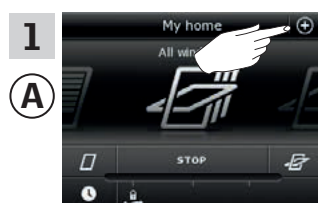

Tap ⊕.

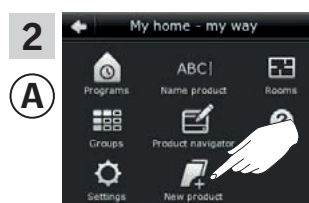

Tap "New product".

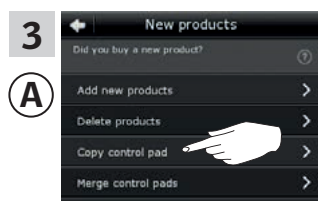

Tap "Copy control pad".

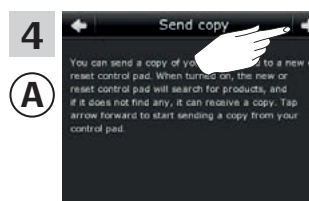

Tap ⇨.

You now have two minutes to execute items 5-8 with ②.

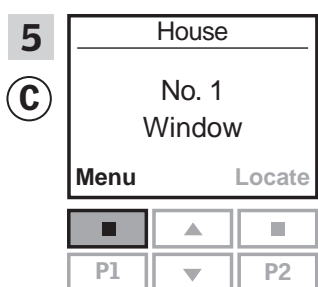

Press "Menu".

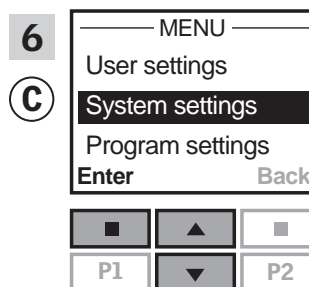

Press to highlight "System settings". Press "Enter" to confirm your choice.

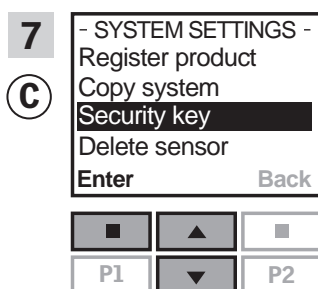

Press to highlight "Security key". Press "Enter" to confirm your choice.

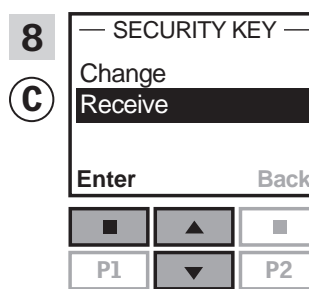

Press to highlight "Receive". Press "Enter" to confirm your choice. The display now indicates that the security key is being transferred.

Continue on the next page

Setting up

Extension of your VELUX INTEGRA® system - Adding a control

3

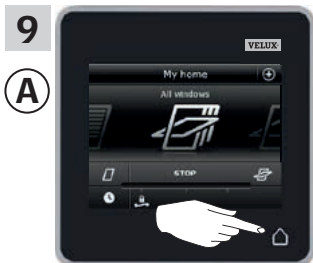

Tap  to finish.

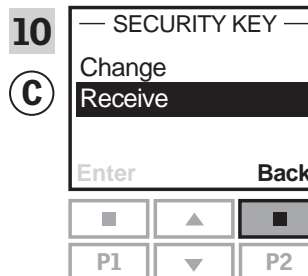

Press  "Back" to finish.

The security key is now identical in both controls, and (C) can operate products again.

If you have additional controls in the same system, you must also synchronise their security keys to make them operate the products again. Please refer to the list on page 84.

To be able to operate all products with (C) as well, you must follow the section *Registering new products* in the directions for use for remote control KLR 100.

Setting up

Extension of your VELUX INTEGRA® system - Adding a control

3

Synchronise the security keys in a VELUX INTEGRA® control pad KLR 200 and a controller KRX 100 in the same system so they both can operate products again

The instructions below show how to transfer the security key of a control pad KLR 200 to a controller KRX 100.

Note: Only available for VELUX INTEGRA® products with radio frequency 868 MHz.

Control pad KLR 200 to **send** the security key is called control (A).
Controller KRX 100 to **receive** the security key is called control (C).

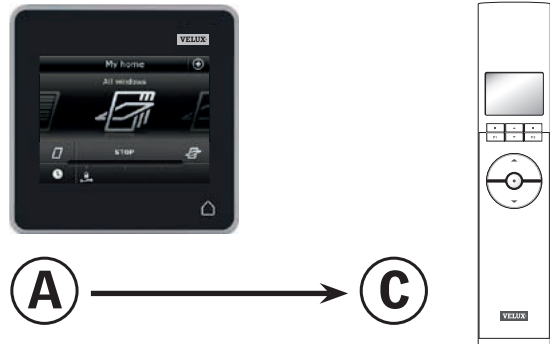

First execute items 1-4 with (A).

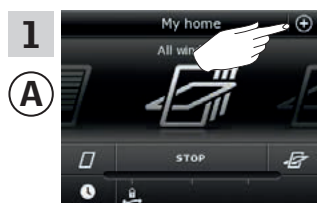

Tap ⊕.

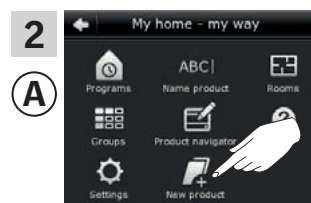

Tap "New product".

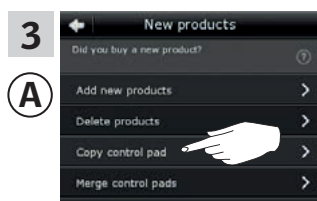

Tap "Copy control pad".

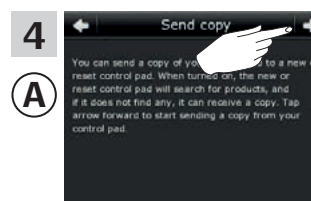

Tap ⇒.

You now have two minutes to execute items 5-8 with (C).

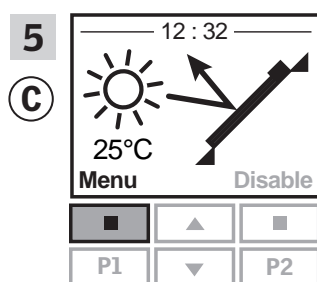

Press [Menu] "Menu".

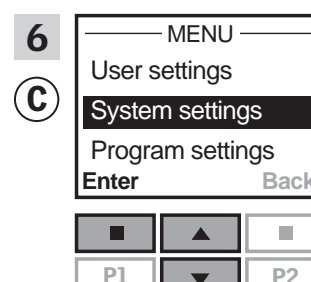

Press [System settings] to highlight "System settings".

Press [Enter] to confirm your choice.

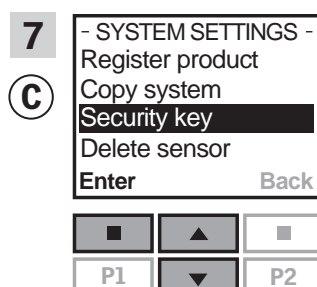

Press [Security key] to highlight "Security key".
Press [Enter] to confirm your choice.

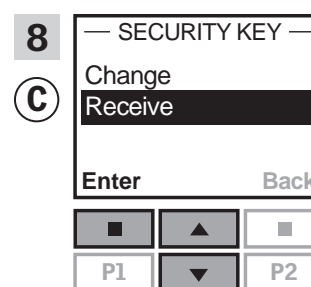

Press [Receive] to highlight "Receive".
Press [Enter] to confirm your choice.

The display now indicates that the security key is being transferred.

Continue on the next page

Setting up

Extension of your VELUX INTEGRA® system - Adding a control

3



Tap  to finish.

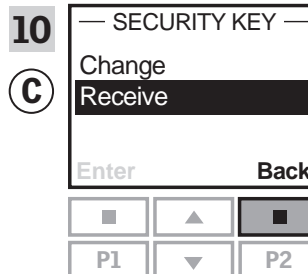

Press  "Back" to finish.

The security key is now identical in both controls, and (C) can operate products again.

If you have additional controls in the same system, you must also synchronise their security keys to make them operate the products again. Please refer to the list on page 84.

To be able to operate all products with (C) as well, you must follow the section *Registering sunscreening products in controller* in the instructions for controller KRX 100.

Setting up

Extension of your VELUX INTEGRA® system - Adding a control

3

Synchronise the security keys in a VELUX INTEGRA® control pad KLR 200 and an interface KLF 100 in the same system so they both can operate products again

The instructions below show how to transfer the security key of a control pad KLR 200 to an interface KLF 100.

Control pad KLR 200 to **send** the security key is called control **(A)**.
Interface KLF 100 to **receive** the security key is called control **(C)**.

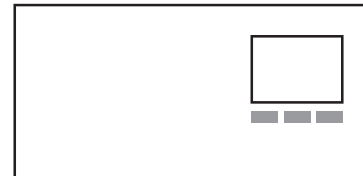

First execute items 1-4 with **(A)**.

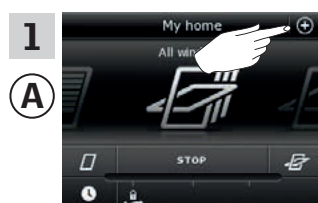

Tap ⊕.

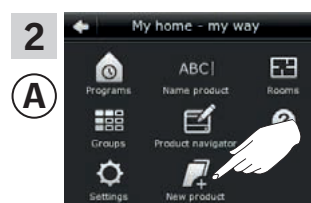

Tap "New product".

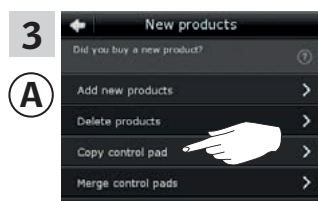

Tap "Copy control pad".

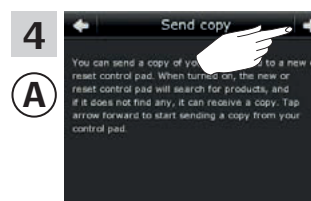

Tap ⇒.

You now have two minutes to execute items 5-6 with **(C)**.

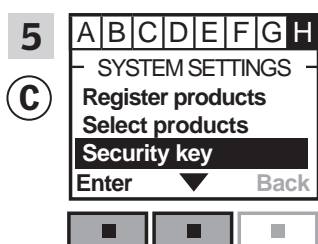

Follow the instructions for the interface until the section where menu item **(H)** is highlighted.
Press **(H)** ▼ to highlight "Security key".
Press **(H)** "Enter" to confirm your choice.

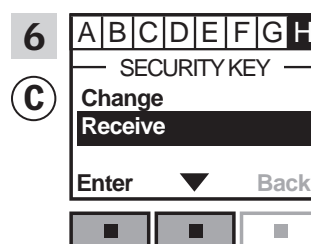

Press **(H)** ▼ to highlight "Receive".
Press **(H)** "Enter" to confirm your choice.

Setting up

Extension of your VELUX INTEGRA® system - Adding a control

3



Tap  to finish.

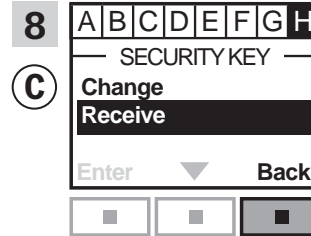

Press  "Back" to finish.

The security key is now identical in both controls, and (C) can operate products again.

If you have additional controls in the same system, you must also synchronise their security keys to make them operate the products again. Please refer to the list on page 84.

To be able to operate all products with (C) as well, you must follow the section *Registering products* in the directions for use for interface KLF 100.

Setting up

Extension of your VELUX INTEGRA® system - Adding a control

3

Synchronise the security keys in a VELUX INTEGRA® control pad KLR 200 and another type of io-homecontrol® controls in the same system so they both can operate products again

The instructions below show how to transfer the security key of a control pad KLR 200 to an io-homecontrol® control.

Note: Only available for VELUX INTEGRA® products with radio frequency 868 MHz.

Control pad KLR 200 to **send** the security key is called control (A).
io-homecontrol® control to **receive** the security key is called control (C).

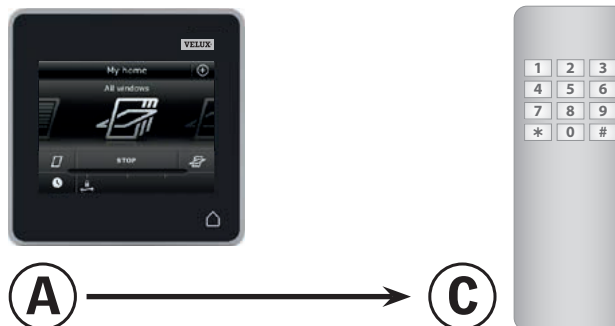

First execute items 1-4 with (A).

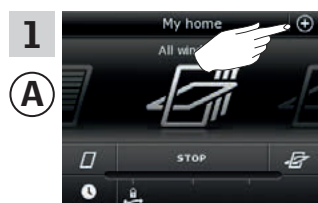

Tap ⊕.

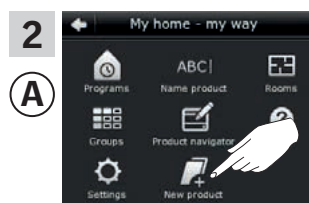

Tap "New product".

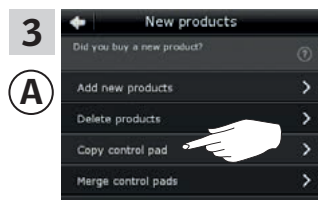

Tap "Copy control pad".

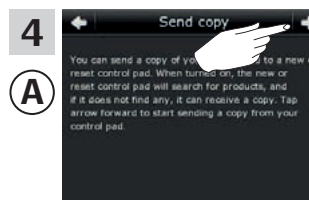

Tap ⇒.

You now have two minutes to execute item 5 with (C).

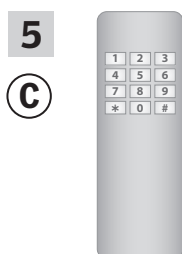

See instructions for the io-homecontrol® control. You may also refer to the section *Joint operation of io-homecontrol® products.*

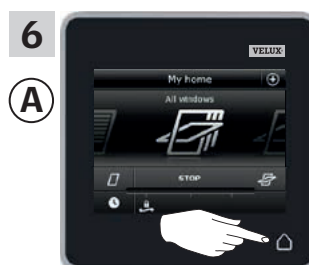

Tap ⏠ to finish.

The security key is now identical in both controls, and (C) can operate products again.

If you have additional controls in the same system, you must also synchronise their security keys to make them operate the products again. Please refer to the list on page 84.

To be able to operate all products with (C) as well, you must follow the instructions for the io-homecontrol® control.

Setting up
Extension of your VELUX INTEGRA® system

3

Deleting products in the control pad

You can delete products from the control pad if you do not want to be able to operate them with the control pad anymore.

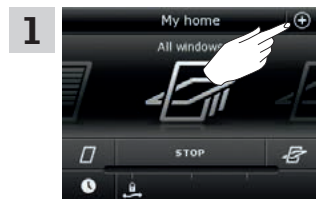

1 Tap ⊕.

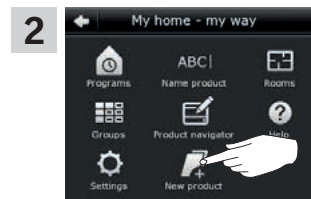

2 Tap "New product".

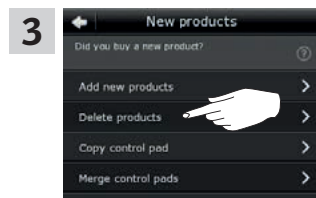

3 Tap "Delete products".

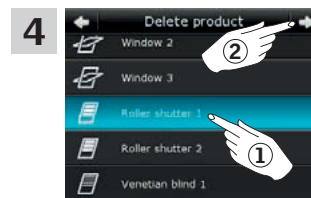

4 Tap the product to be deleted, in this case "Roller shutter 1" ①. **Note:** The individual products can be identified by tapping the icon. See also the section *Finding products*. Tap ⇒ ②.



5 Tap "Yes".



6 Tap ⏠ to finish.

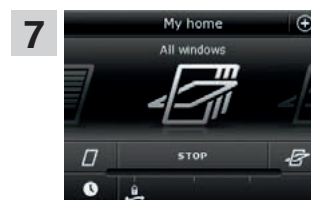

7 You cannot find the product "Roller shutter 1" in the product navigator anymore.

Setting up

Extension of your VELUX INTEGRA® system - Joint operation of io-homecontrol® products

3

To operate other types of io-homecontrol® products than VELUX INTEGRA® products with control pad KLR 200 or operate your VELUX INTEGRA® products with another type of io-homecontrol® control than control pad KLR 200, all products must have the same security key.

Please refer to the lists with reference pages in the section *Extension of your VELUX INTEGRA® system* to see how control pad KLR 200 can be combined with other specifically described types of io-homecontrol® products and systems using the same radio frequency when communicating. Below you can see how to configure io-homecontrol® products in general to include them in joint systems and how to create a new security key. In principle, control pad KLR 200 is combinable with other controls without any need for further instructions but please be aware that not all controls offer joint operation of io-homecontrol® products.

Under the lid on the back of the control pad KLR 200, a **key button** can be activated by pressing it with a pointed object. Depending on whether you want to **receive**, **send** or **create** a new security key, you must press this key button for a certain period of time.

Receive the security key of another control:

Press the key button briefly (max 2 seconds) until the diode starts flashing slowly  (1 flash per sec).

Send the security key to another control:

Press the key button a little longer (2-7 seconds) until the diode starts flashing a little faster  (3 flashes per sec).

Create a new security key:

Press the key button for a long time (7-15 seconds) until the diode starts flashing very fast  (7 flashes per sec).

IMPORTANT: Prior to creating a new security key, you must check that all products in the control pad are operable. If a product is not operable, this product will not be operable with a new security key either.

To **cancel** receiving, sending or creating a security key, you must **press and hold the key button** until the diode goes out.

The instructions on the following pages show how to transfer the security key depending on which of the three situations is relevant.

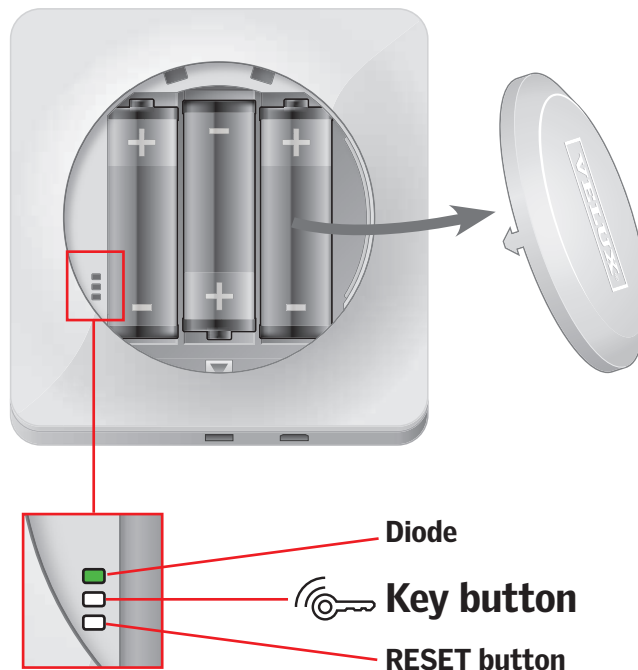

Sending the security key to another io-homecontrol® control

VELUX INTEGRA® control pad KLR 200

Tap  to ensure that the control pad display is on.

Press the key button for 2-7 seconds until the diode starts flashing  (3 flashes per sec).



Note: The transfer can be interrupted by pressing the key button once more.

io-homecontrol® control 

Press the key button briefly (max 2 seconds) until the diode starts flashing slowly  (1 flash per sec).

When the diode on your control pad KLR 200 stays green for about 2 seconds  and then goes out, the transfer has succeeded.

If the diode on your control pad KLR 200 flashes red quickly three consecutive times  and then goes out, the transfer has failed. In this case, you must repeat the process with both controls.

When the security key has been sent, you have to add the products from control pad KLR 200 to io-homecontrol® control . Please refer to the instructions for io-homecontrol® control .

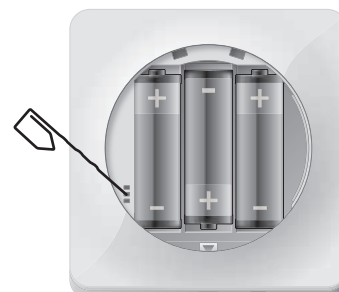
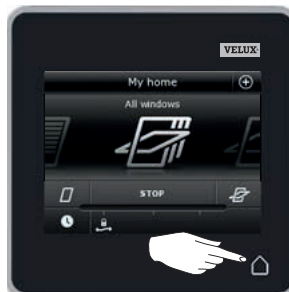

Setting up

Extension of your VELUX INTEGRA® system - Joint operation of io-homecontrol® products

Receiving the security key of another io-homecontrol® control

io-homecontrol® control (A)

Press the key button for 2-7 seconds until the diode starts flashing  (3 flashes per sec).

Note: The transfer can be interrupted by pressing the key button once more.

VELUX INTEGRA® control pad KLR 200

Tap  to ensure that the control pad display is on.

Press the key button briefly (max 2 seconds) until the diode starts flashing slowly  (1 flash per sec).

When the diode on your control pad KLR 200 stays green for about 2 seconds  and then goes out, the transfer has succeeded.

If the diode on your control pad KLR 200 flashes red quickly three consecutive times  and then goes out, the transfer has failed. In this case, you must repeat the process with both controls.

When the security key has been received, you have to add the products from io-homecontrol® control (A) to control pad KLR 200. Please refer to the section *Adding products to the control pad*.

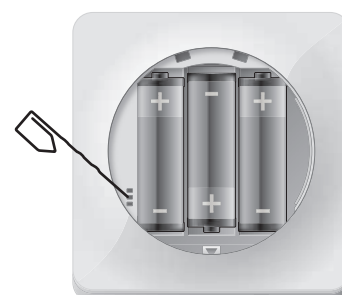



Creating a new security key in VELUX INTEGRA® control pad KLR 200

Tap  to ensure that the control pad display is on.

Note: All products in the control pad must be operable; otherwise they will not be operable with a new security key either. Therefore please make sure that all products are connected to power and within range before continuing.

Press the key button for 7-15 seconds until the diode starts flashing very fast  (7 flashes per sec).

When the diode on your control pad KLR 200 stays green for about 2 seconds  and then goes out, the creation has succeeded.

If the diode on your control pad flashes red quickly three consecutive times  and then turns off, the creation has failed. Some products are now not operable with this control pad anymore.

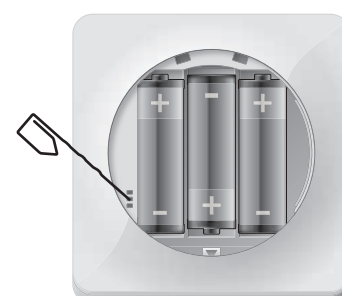
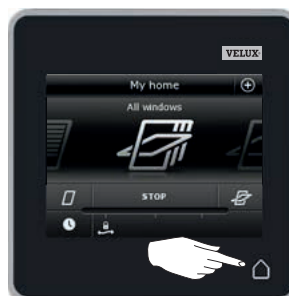

Setting up
Settings

3

Time and date

You can set time and date at any time.

Note: You cannot use programs until you have set time and date.

Setting time

The example shows how to set time.

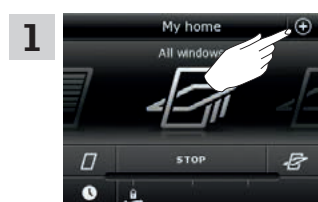

1 Tap ⊕.

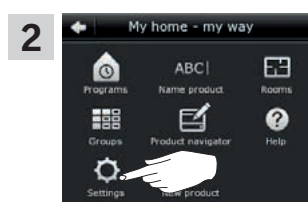

2 Tap "Settings".

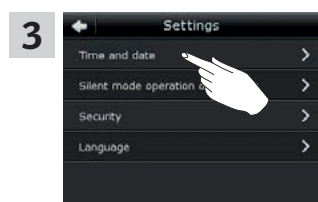

3 Tap "Time and date".

Set hours and minutes

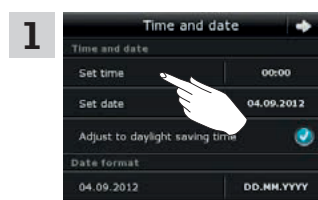

1 Tap "Set time".

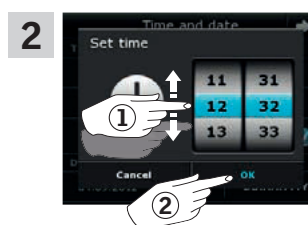

2 Roll the wheel in the directions of the arrows to choose hours and minutes ①. Tap "OK" ②.

Switch between 12 hours (am/pm) and 24 hours format

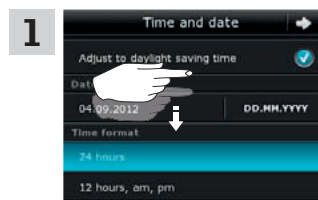

1 Scroll down the display until "Time format" is shown.

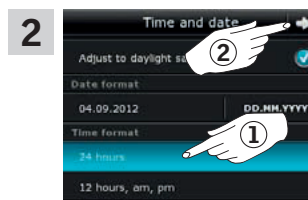

2 Tap either 12 or 24 hours format ①. Tap ⇨ ②.

Adjust to summer time

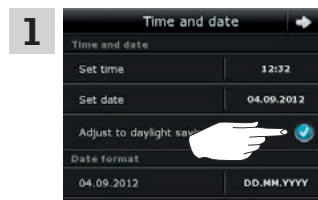

1 Time switches automatically from summer time/daylight saving time to standard time and vice versa. This function can be disabled by removing the tick for "Adjust to summer time".

Continue on the next page

Setting up
Settings

3

Setting date

The example shows how to set date.

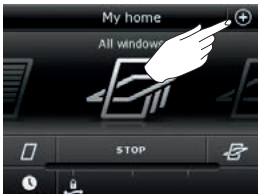
1  Tap ⊕.

2  Tap "Settings".

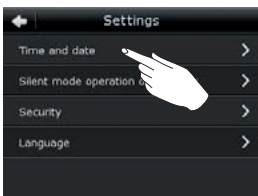
3  Tap "Time and date".

Set date

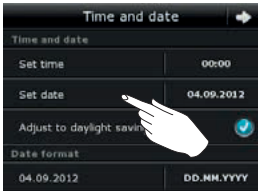
1  Tap "Set date".

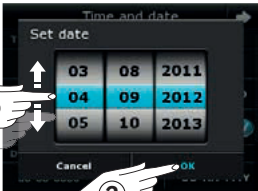
2  Roll the wheel in the directions of the arrows to choose day, month and year ①. Tap "OK" ②.

Set date format

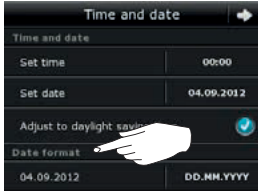
1  Scroll down the display and tap "Date format".

2  Roll the wheel in the directions of the arrows to choose date format ①. Tap "OK" ②.



Tap ⇐ or ⇨ when you have finished setting time and/or date.

Language

You must choose a language the first time the control pad is put into operation. The chosen language can be changed at any time. The example shows how to change language.

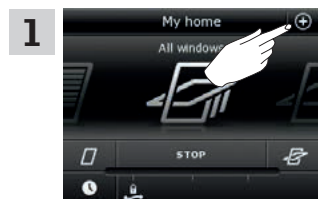

Tap ⊕.

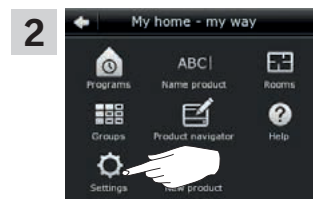

Tap "Settings".

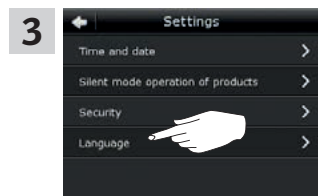

Tap "Language".



Roll the wheel in the directions of the arrows to choose language ①. Tap ⇨ ②.

Silent mode operation of products

Some products can be set to silent mode when operated. This may be convenient, for instance if the products are automatically activated by a program at night.

Note: Products set to silent mode operation run slower.

The example shows how to set products to run in silent mode.

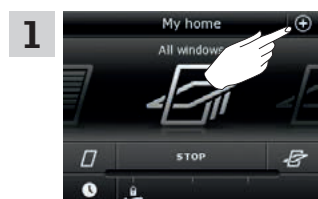

Tap ⊕.

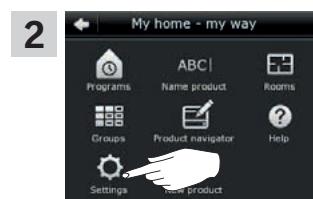

Tap "Settings".

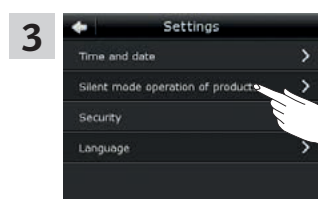

Tap "Silent mode operation of products".

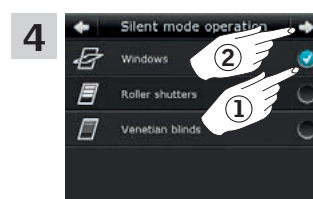

Tick the product(s) to run silently ①. Tap ⇨ ②.

Setting up
Resetting the control pad

3

The control pad can be reset to its initial factory settings if you want to delete all registered products and personal settings and start afresh.

Note: If you have one control pad only, all products must be reset before you can register them in the control pad again, see the section *If the initial set-up fails*. If you have an additional control, you can copy this to the control pad you are resetting instead, see the section *Adding a control*.



1 Tap  to ensure that the control pad display is on.

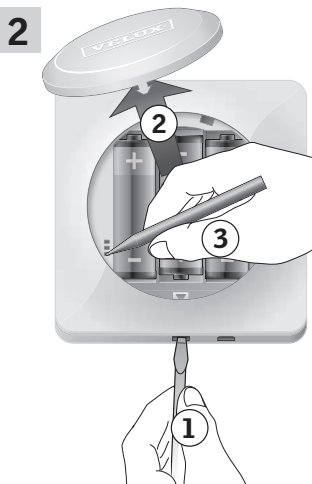

2 Remove the battery compartment lid by pressing the release button with a screwdriver as illustrated ①, ②. Press the RESET button on the back of the control pad with a pointed object for at least 5 seconds ③. Replace lid.

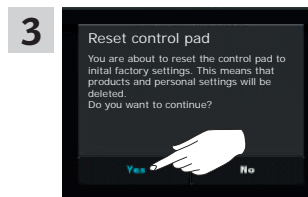

3 In the display screen, tap "Yes" to confirm that you want to reset the control pad.

The control pad has now been reset. To be able to use it, the products must be registered again. See the section *Initial set-up*.

Setting up
Security

3

Password

To ensure that your settings cannot be changed by anyone except yourself, access to the settings of the control pad can be limited by means of a password.

The example shows how to lock the settings by means of a password.

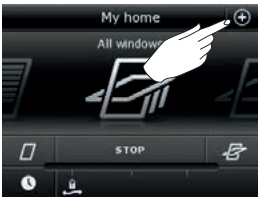
- 1** 

Tap ⊕.

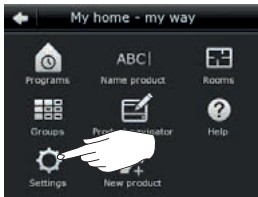
2 

Tap "Settings".

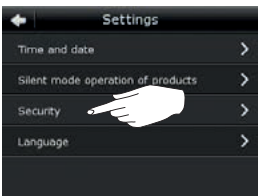
- 3** 

Tap "Security".

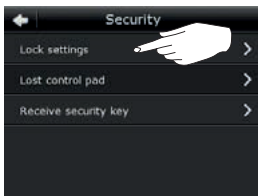
4 

Tap "Lock settings".

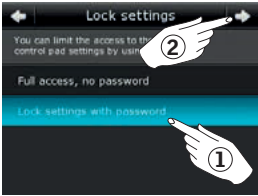
- 5** 

Tap "Lock settings with password" ①.
Tap ⇒ ②.

6 

Enter the password you have chosen (at least 4 characters) ①.
For use of keyboard, see the section *Keyboard*.
Tap ⇒ ②.

- 7** 

Enter the chosen password once more ①.
Tap ⇒ ②.

- 8** 

Tap ⏠ to finish.

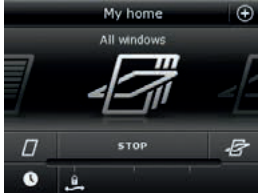
9 

Access to the settings of the control pad has now been restricted.

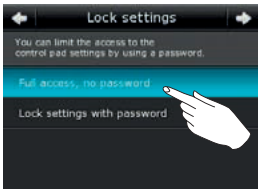
- 

To cancel the password, execute items 1-5 and tap "Full access, no password" in item 5.

Changing the security key

Controls and products have a security key to ensure that only controls with the authorised security key can operate your products. If you suspect that the security key in your control has been changed without your consent, you can create a new one. If you change the security key, all products in the system must have the new security key.

"Control" is used as a generic term for all devices that can operate VELUX INTEGRA® products.

To find the control that operates the same system as your control pad KLR 200 and needs a change of security key, please see the page references below.



VELUX INTEGRA®
control pad KLR 200
(3LR A02)
Pages 104-105



VELUX INTEGRA®
interface KLF 100
(3LF D01)
Pages 110-111

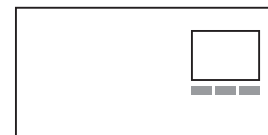

VELUX INTEGRA®
remote control KLR 100
(3LR A01)
Pages 106-107



Other types of io-homecontrol®
controls
Pages 112-113



VELUX INTEGRA®
controller KRX 100
(3LF D02)
Pages 108-109

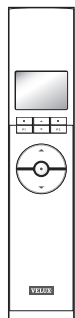

Setting up

Security - Changing the security key

3

Changing the security key in systems with one or more VELUX INTEGRA® control pads KLR 200

Control pad KLR 200 to **send** the security key is called control **Ⓐ**.
Control pad KLR 200 to **receive** the security key is called control **Ⓑ**.
It does not matter which control pad is called **Ⓐ** or **Ⓑ**.

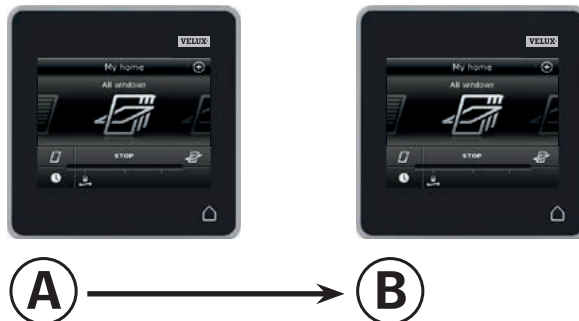

First execute items 1-6 with **Ⓐ**.

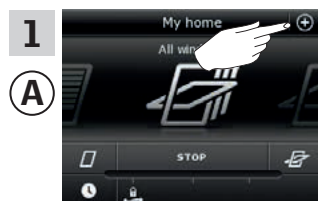

Tap ⊕.

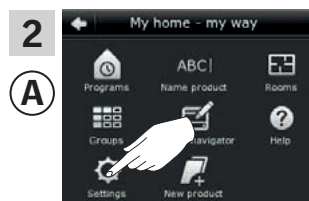

Tap "Settings".

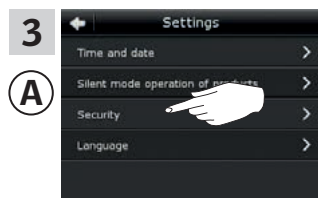

Tap "Security".

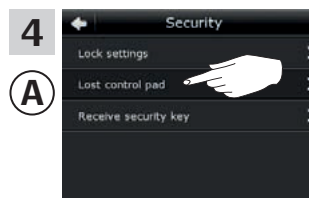

Tap "Lost control pad".

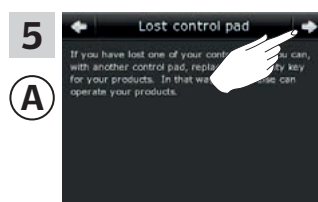

Tap ⇒.

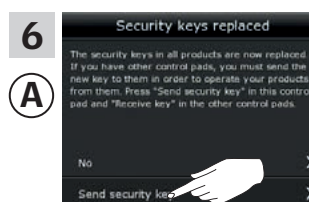

Tap "Send security key".

Note: Tap "No" if you have one control pad only.

Continue on the next page

Setting up
Security - Changing the security key

3

You now have two minutes to execute items 7-12 with ②.

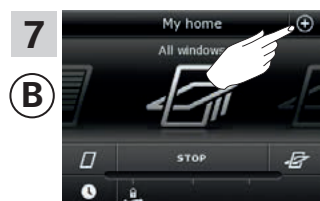

Tap +.

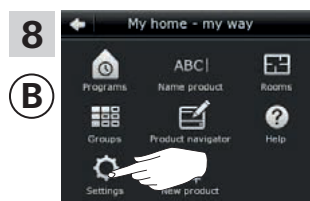

Tap "Settings".

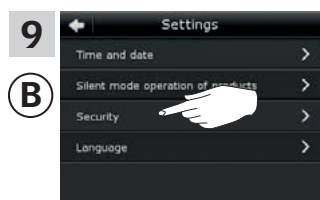

Tap "Security".

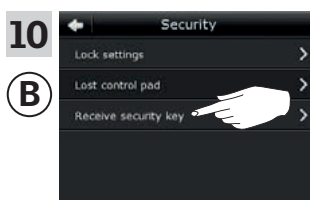

Tap "Receive security key".

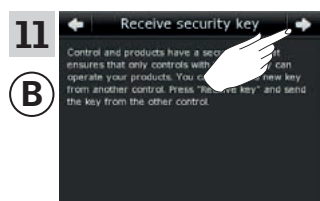

Tap →.

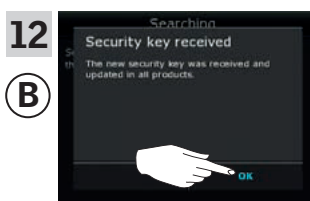

Tap "OK".

The security key is now identical in both controls.

If you have additional controls, you must execute item 6 with ① and items 7-12 or corresponding items for each additional ②, please see the page references in the section *Changing the security key*.



Tap ⏠ or corresponding "Back" key on all controls to finish.

Setting up

Security - Changing the security key

3

Changing the security key in systems with one or more VELUX INTEGRA® control pads KLR 200 and remote controls KLR 100

Control pad KLR 200 to **send** the security key is called control **A**.
Remote control KLR 100 to **receive** the security key is called control **B**.

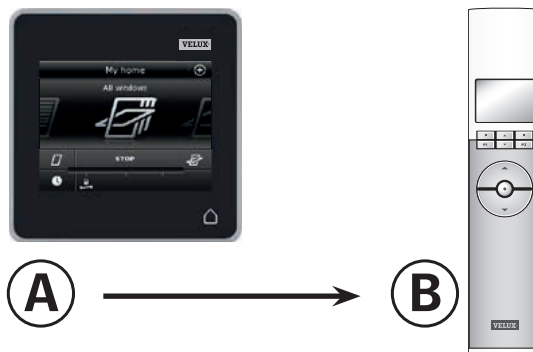

First execute items 1-6 with **A**.

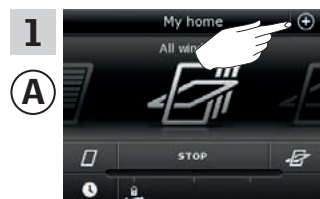

Tap **+**.

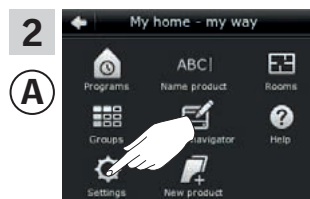

Tap "Settings".

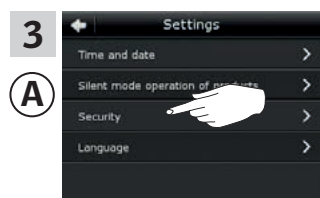

Tap "Security".

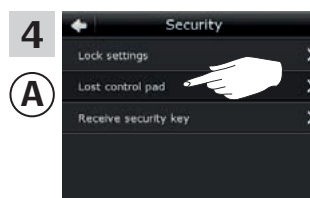

Tap "Lost control pad".

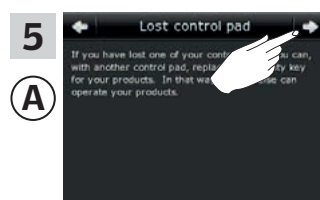

Tap **⇒**.

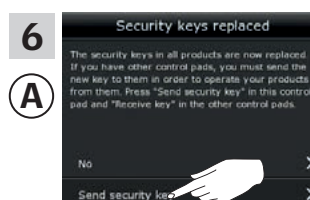

Tap "Send security key".

Continue on the next page

Setting up

Security - Changing the security key

3

You now have two minutes to execute items 7-10 with (B).

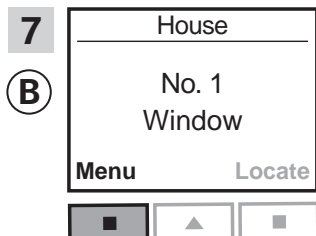

Press "Menu".

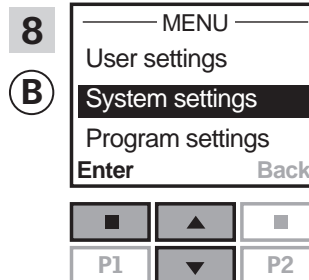

Press to highlight "System settings".
Press "Enter" to confirm your choice.

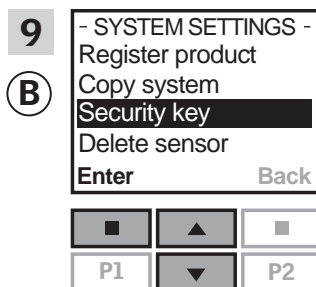

Press to highlight "Security key".
Press "Enter" to confirm your choice.

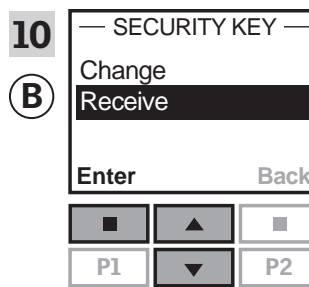

Press to highlight "Receive".
Press "Enter" to confirm your choice.
The display now indicates that the security key is being transferred.

The security key is now identical in both controls.

If you have additional controls, you must execute item 6 with (A) and items 7-10 or corresponding items for each additional (B), please see the page references in the section *Changing the security key*.



Tap or corresponding "Back" key on all controls to finish.

Setting up

Security - Changing the security key

3

Changing the security key in systems with one or more VELUX INTEGRA® control pads KLR 200 and controllers KRX 100

Note: Only available for VELUX INTEGRA® products with radio frequency 868 MHz.

Control pad KLR 200 to **send** the security key is called control **(A)**.
Controller KRX 100 to **receive** the security key is called control **(B)**.

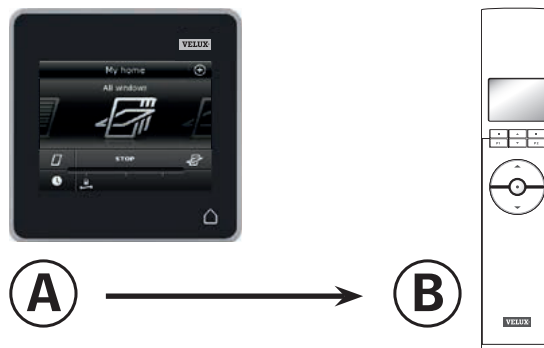

First execute items 1-6 with **(A)**.

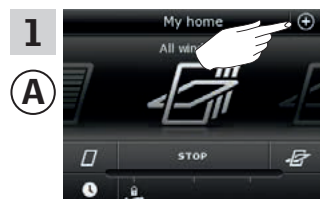

Tap ⊕.

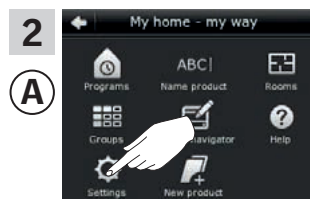

Tap "Settings".

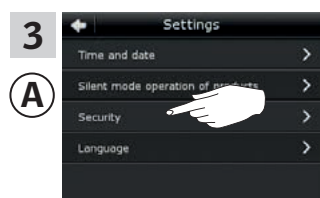

Tap "Security".

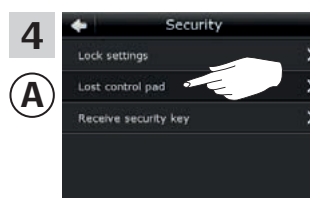

Tap "Lost control pad".

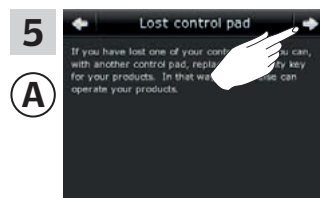

Tap ⇒.

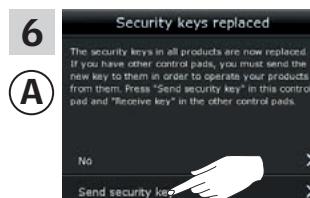

Tap "Send security key".

Continue on the next page

Setting up
Security - Changing the security key

3

You now have two minutes to execute items 7-10 with (B).



Press "Menu".

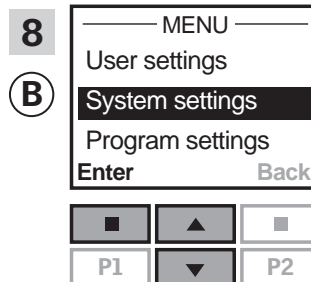

Press to highlight "System settings".
Press "Enter" to confirm your choice.

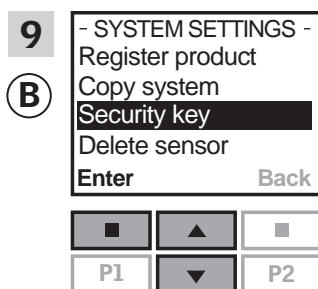

Press to highlight "Security key".
Press "Enter" to confirm your choice.

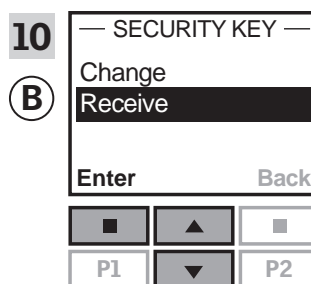

Press to highlight "Receive".
Press "Enter" to confirm your choice.
The display now indicates that the security key is being transferred.

The security key is now identical in both controls.

If you have additional controls, you must execute item 6 with (A) and items 7-10 or corresponding items for each additional (B), please see the page references in the section *Changing the security key*.



Tap or corresponding "Back" key on all controls to finish.

Setting up

Security - Changing the security key

3

Changing the security key in systems with one or more VELUX INTEGRA® control pads KLR 200 and interfaces KLF 100

Control pad KLR 200 to **send** the security key is called control (A). Interface KLF 100 to **receive** the security key is called control (B).

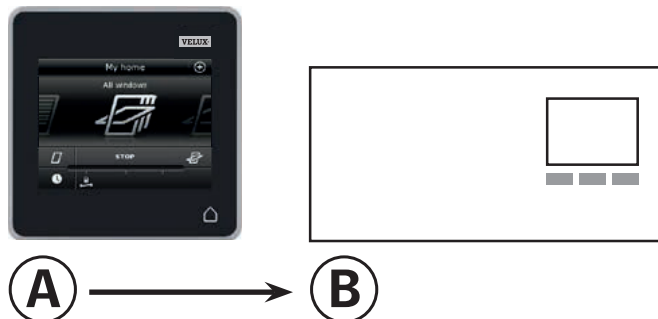

First execute items 1-6 with (A).

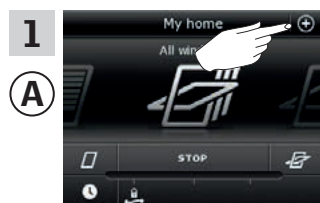

Tap ⊕.

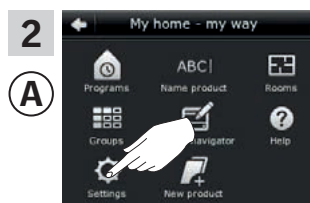

Tap "Settings".

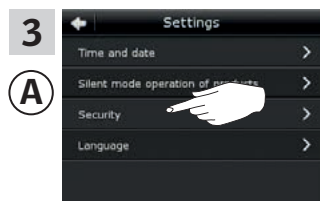

Tap "Security".

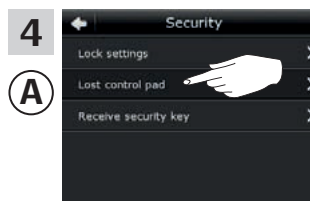

Tap "Lost control pad".

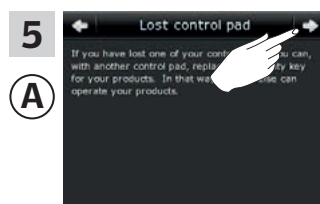

Tap ⇒.

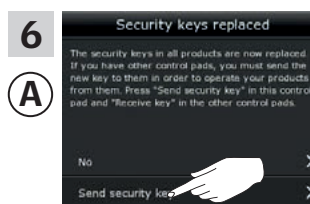

Tap "Send security key".

Continue on the next page

Setting up

Security - Changing the security key

3

You now have two minutes to execute items 7-8 with ②.

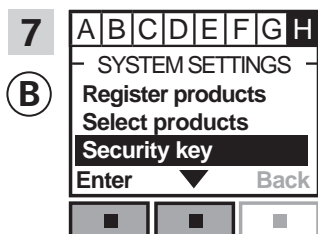

7 Follow the instructions for the interface until the section where menu item H is highlighted.
Press ▼ to highlight "Security key".
Press "Enter" to confirm your choice.

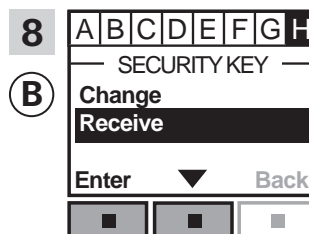

8 Press ▼ to highlight "Receive".
Press "Enter" to confirm your choice.
The display now indicates that the security key is being transferred.

The security key is now identical in both controls.

If you have additional controls, you must execute item 6 with ① and items 7-8 or corresponding items for each additional ②, please see the page references in the section *Changing the security key*.



Tap or corresponding "Back" key on all controls to finish.

Setting up
Security - Changing the security key

3

Changing the security key in systems with one or more VELUX INTEGRA® control pads KLR 200 and other types of io-homecontrol® controls

Note: Only available for VELUX INTEGRA® products with radio frequency 868 MHz.

Control pad KLR 200 to **send** the security key is called control (A).
io-homecontrol® control to **receive** the security key is called control (B).

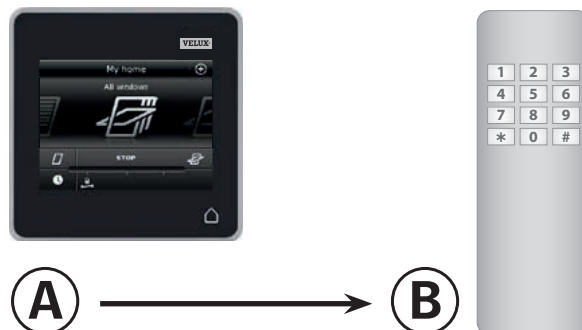

First execute items 1-6 with (A).

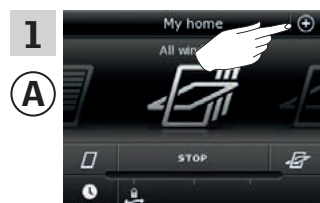

Tap ⊕.

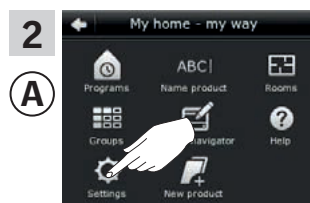

Tap "Settings".

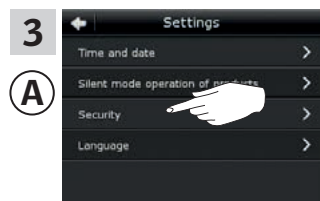

Tap "Security".

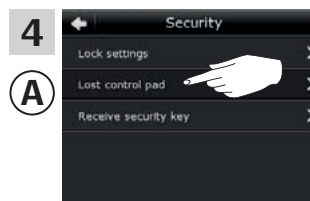

Tap "Lost control pad".

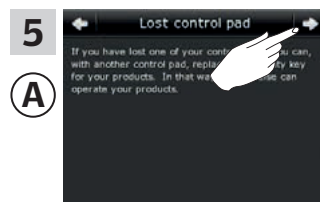

Tap ⇒.

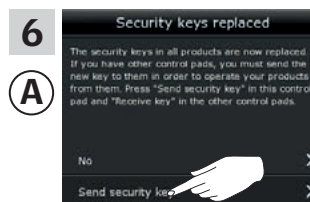

Tap "Send security key".

Continue on the next page

You now have two minutes to execute item 7 with ⑦.

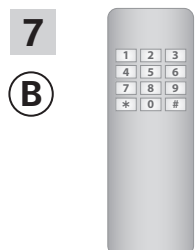

See instructions for the io-homecontrol® control. You may also refer to the section *Joint operation of io-homecontrol® products.*

The security key is now identical in both controls.

If you have additional controls, you must execute item 6 with ⑥ and item 7 or corresponding items for each additional ⑦, please see the page references in the section *Changing the security key.*



Tap  on the control pad to finish.

Installation

Fitting the control pad to the wall

4

You can secure the control pad directly to the wall without using the holder supplied **A**. The control pad will be almost flush with the wall and you will always know where it is.

The control pad can be made movable by fitting the holder supplied to the wall **B** and placing the control pad in the holder.

You may also choose not to fit the control pad to the wall.

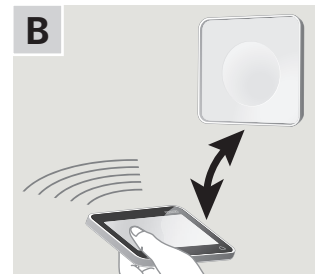

A Control pad fitted directly to the wall



The holder is not required.



Remove the battery compartment lid by pressing the release button with a screwdriver as illustrated.

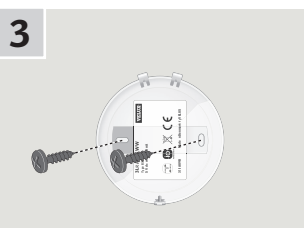

Fit the battery compartment lid to the wall with the two screws supplied.



Clip on the control pad to the battery compartment lid.

B Control pad with holder

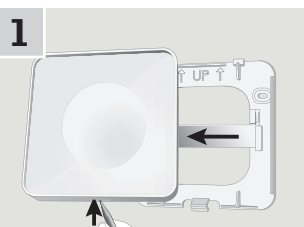

Press with a pointed object at the bottom of the holder and remove the back section.

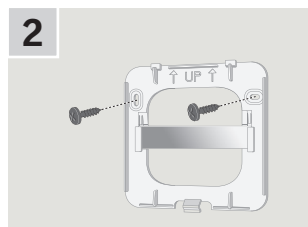

Fit the back section onto the wall with the two screws supplied.



Clip on the holder to the back section.

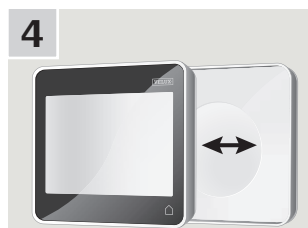

Place the control pad in the holder. The control pad is secured by means of built-in magnets.

Installation

Repositioning the rain sensor in case of retrofitting

4

Retrofitting a VELUX INTEGRA® roller shutter or awning blind onto a VELUX INTEGRA® centre-pivot window

If you want to retrofit a VELUX INTEGRA® roller shutter or awning blind onto your VELUX INTEGRA® centre-pivot window, you must reposition the rain sensor to the side channel of the roller shutter or the awning blind.

Note: The mains or battery supply must be switched off while repositioning the rain sensor.

- 1 Move the rain sensor from window side cover to roller shutter or awning blind side channel.
Important: The surface to which the rain sensor is to be adhered must be clean and dry.
- 2 Lead the cable under roller shutter or awning blind without pulling it tight.
- 3 Lead the cable into the window as shown.

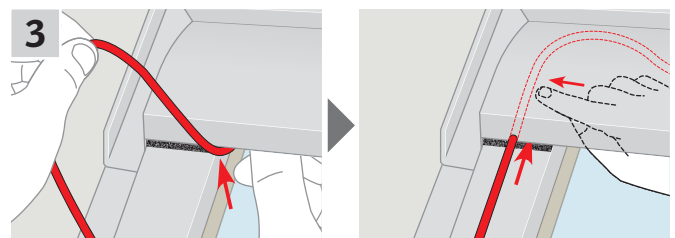
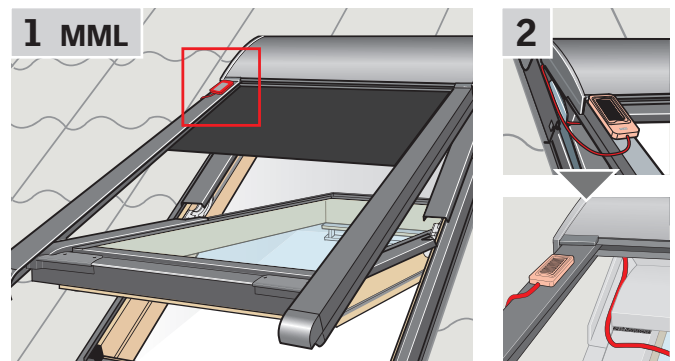
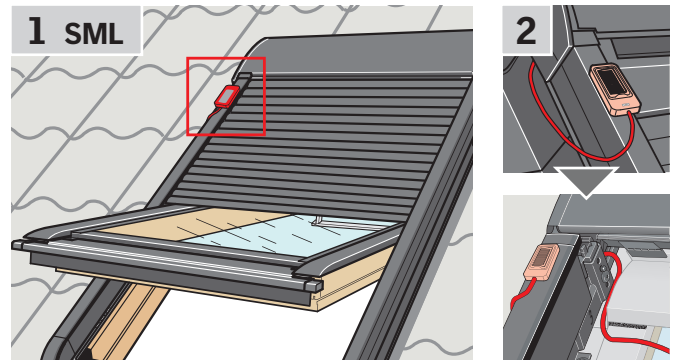

Declaration of Conformity

For products offered in Europe

In accordance with the Council Directive 2006/95/EC

We herewith declare that the VELUX INTEGRA® products

- roof windows GGL (----21) and GGU (----21),
 - Solar roof windows GGL (----30) and GGU (----30),
 - flat roof window CVP (3MX A02),
 - modular skylight HVC (3MA A01, 3MA A02, 3MA A03, 3MA A04 and 3MA A05),
 - conversion kit KMX 100 (3MG A01, 3UC A02, 3LA A01 and 3LR A01) for VELUX roof windows GGL and GGU,
 - conversion kit KMX 200 (3MX A01, 3LA A01 and 3LR A01) for VELUX roof windows GHL, GHU, GPL, GPU, GTL, GTU and VKU,
 - Solar conversion kits KSX 100 (3SM B01, 3SD B01 and 3LR A01) and KSX 100K (3SM BK01 and 3LR A02) for VELUX roof windows GGL and GGU and
 - control pad KLR 200 (3LR A02)
- are in conformity with the Machinery Directive 2006/42/EC, EMC Directive 2004/108/EC, Low Voltage Directive 2006/95/EC and R&TTE Directive 1999/5/EC and
- have been manufactured in accordance with the harmonised standards EN 300220-2, EN 301489-3, EN 55014-1 (2006-12), EN 55014-2(1997-02), EN 55022(2006-09), EN 55024(1998-09), EN 61000-3-2(2006-04), EN 61000-3-3(1995-01), EN 50366, EN 60335-1, EN 60335-2-103, EN 61558-1 and EN 61558-2-16.

The above-mentioned VELUX INTEGRA® products are to be considered as machines, which are not to be put into service until they have been installed according to instructions and requirements.

The total system then complies with the essential requirements of the Council Directives 2006/42/EC, 2004/108/EC, 2006/95/EC and 1999/5/EC.

VELUX A/S:

(Lars Gylstorff, Product Management)

Ådalsvej 99, DK-2970 Hørsholm 22-12-2011

CE DoC 942000-00

For products offered in Australia, Canada, Japan, New Zealand and the United States of America

We herewith declare that the VELUX INTEGRA® products

- control pad KLR 200 (3LR A02 US),
- Solar skylights VSS and VCS and,
- skylights VSE and VCE

comply with part 15 of the FCC rules, RSS-210 of the IC rules, ARIB STD T33 and T66 and AS/NZS 4268:

- Control pad
FCC ID: XSG832794, IC ID: 8642A-832794 and Certificate of Radio Equipment in Japan: No. 13215185,
- Window operator (solar powered skylight operator)
FCC ID: XSG832876 and IC ID: 8642B-832876,
- Window operator (electrically powered skylight operator)
FCC ID: XSG863765 and IC ID: 8642A-863765.